



# A Bolometer Array for the Spectral Energy Distribution (SPEED) Camera

R. F. Silverberg<sup>1</sup>, S. Ali<sup>2</sup>, A. Bier<sup>3</sup>, B. Campano<sup>3</sup>, T. C. Chen<sup>3</sup>, E. S. Cheng<sup>4</sup>,  
D. A. Cottingham<sup>3</sup>, T. M. Crawford<sup>5</sup>, T. Downes<sup>5</sup>, F. M. Finkbeiner<sup>6</sup>, D. J. Fixsen<sup>6</sup>,  
D. Logan<sup>7</sup>, S. S. Meyer<sup>5</sup>, C. O'Dell<sup>7</sup>, T. Perera<sup>5</sup>, E. H. Sharp<sup>3</sup>, P. T. Timbie<sup>2</sup>,  
and G. W. Wilson<sup>7</sup>

<sup>1</sup>Laboratory for Astronomy and Solar Physics, NASA/Goddard Space Flight Center, Greenbelt, MD 20771 USA

<sup>2</sup>Department of Physics, University of Wisconsin, Madison, WI 53706 USA

<sup>3</sup>Global Science and Technology, Greenbelt, MD 20771 USA

<sup>4</sup>Conceptual Analytics, Glenn Dale, MD 20769 USA

<sup>5</sup>Enrico Fermi Institute, University of Chicago, Chicago, IL 60637 USA

<sup>6</sup>SSAI, Lanham, MD 20706 USA

<sup>7</sup>Department of Astronomy, University of Massachusetts, Amherst, MA 01003 USA



# Overview of Talk

- SPEED Science Objectives
- Instrument Design
- Frequency Selective Bolometer (FSB)
- Detector Array Considerations
- Expected Performance
- Current Status

# Scientific Objectives

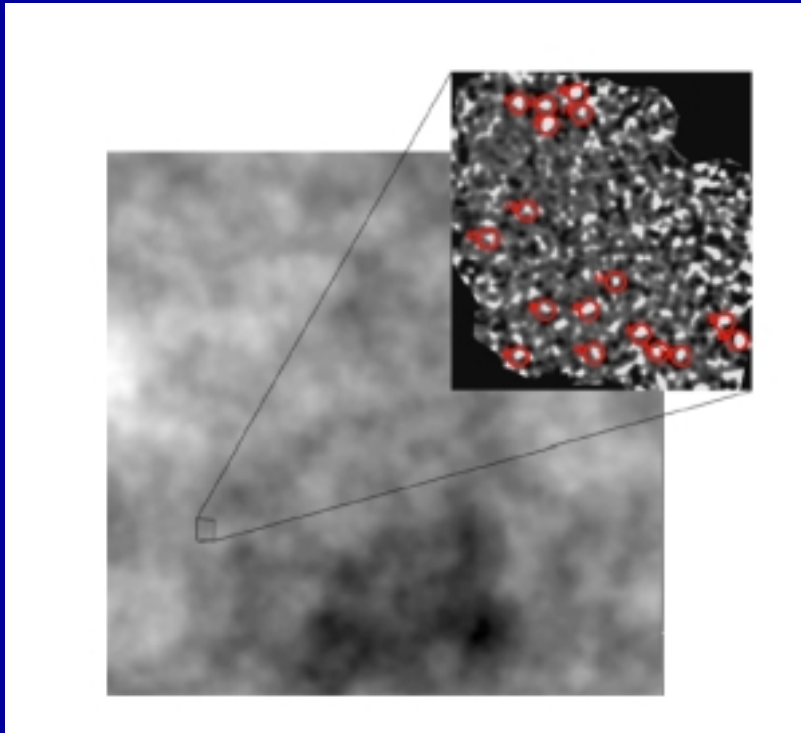

- Protogalaxies
- Spectral Energy Distribution
- Dust
- Galaxy Formation Era
- Negative K correction

# ProtoGalaxy Spectra

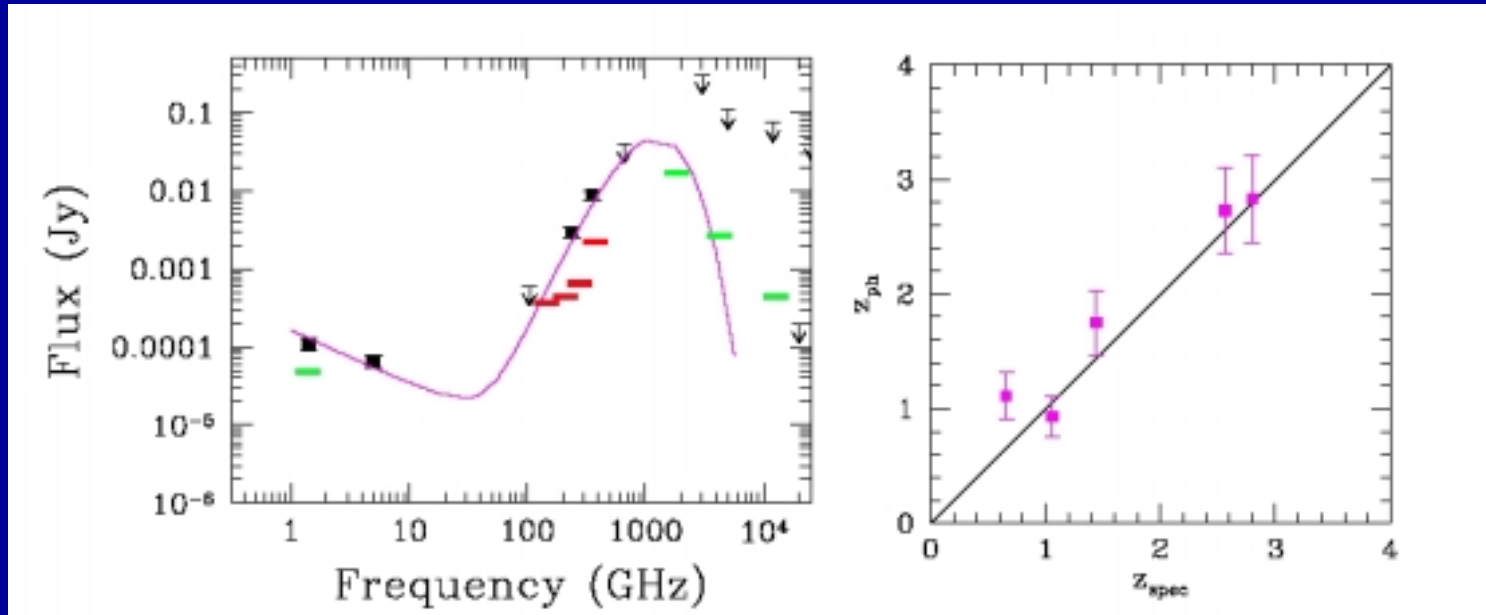

- Spectral Energy Distribution
- Photometric vs Spectroscopic Redshift

# Instrument Design

- SPEED is designed for ground-based observing at millimeter telescopes
- HHT (10m) for initial run
- LMT (50m) later
- Simultaneous and coincident, spatial and spectral information

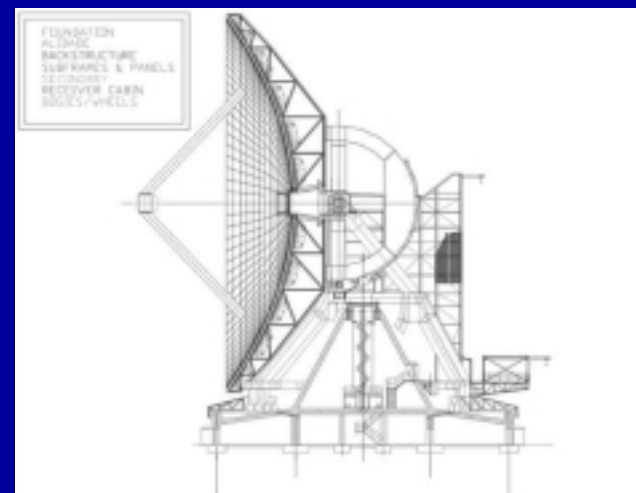

# Frequency Selective Bolometer

- Absorbs radiation in a small band
- Passes radiation outside of the band
- Contains resonant absorber and temperature sensor and  $\lambda/4$  resonant backshort
- Conductive(Au) crosses patterned on  $0.5\mu\text{m}$  thick low-stress  $\text{Si}_x\text{N}_y$  free-standing suspended substrate
- Downside
  - Requires large focal ratio optics F/4 or larger
  - Large device ( $\sim 1\text{ cm} \times 1\text{ cm}$ )
- Fabrication-see poster by Chen et al. - Y14

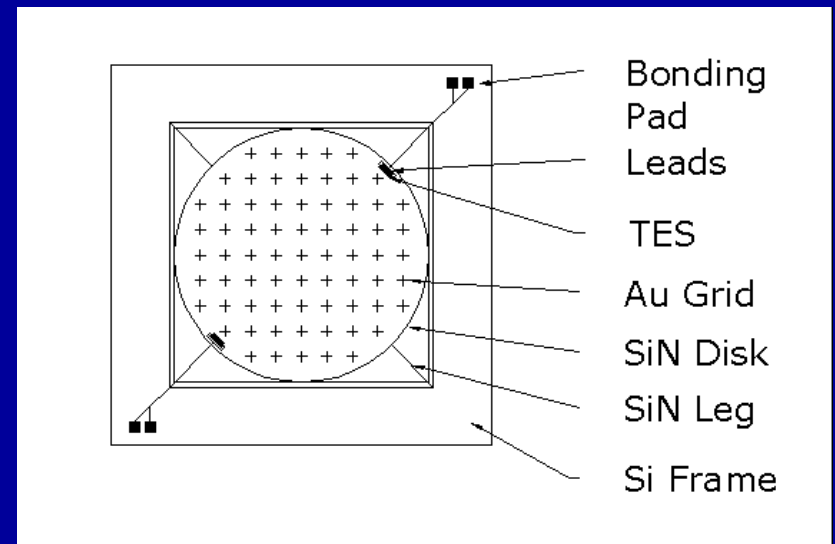

FSB Absorber Layer



# Temperature Sensor/Electronics

- TES temperature sensor
- Mo/Au proximity effect bilayer
- Operating voltage-biased
- Thermal Conductance-margin x4
- Ti/Al/Ti superconducting leads
- SQUID array/ time multiplexer (NIST)

# FSB Performance

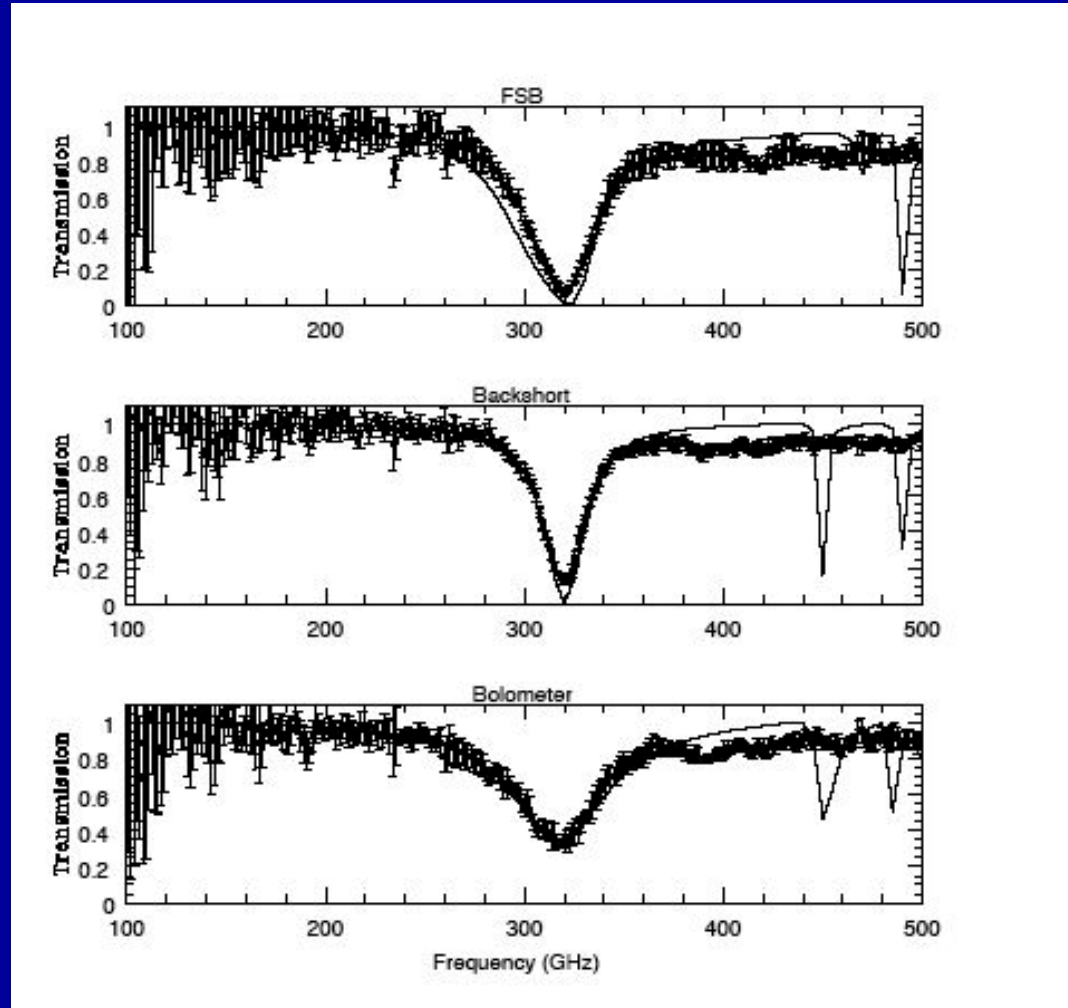



# A SPEED Pixel

- Two Component FSB
- 4 FSB Stack
- Shortest wavelength first
- Terminate with absorber
- 150-375 GHz coverage
- Electrical connection through superconducting leads to SQUID readout
- Shunt Resistor
- Mount provides correct alignment/spacing

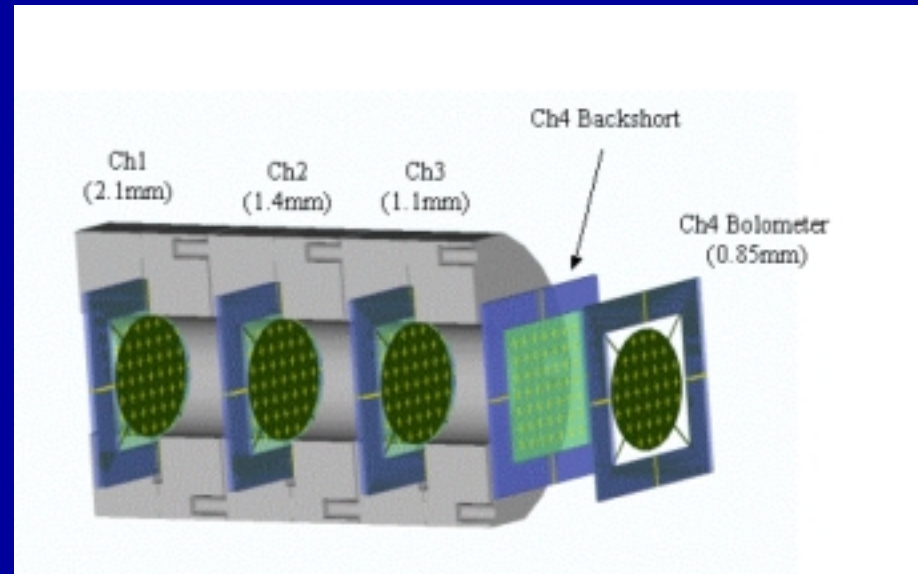

# The SPEED Photometer

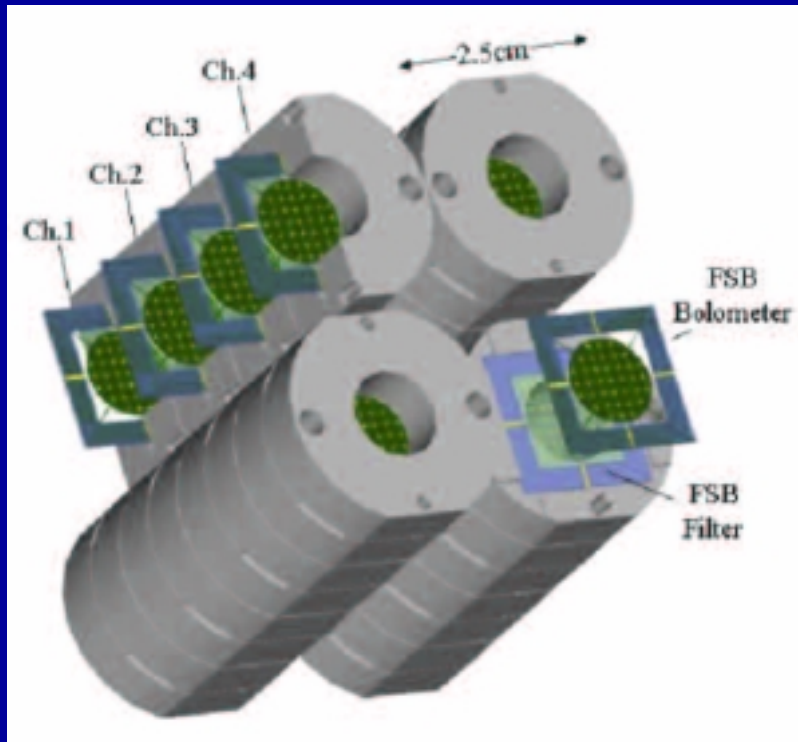

- Compact
- Simultaneous spatial and spectral information
- Efficient
- Horn-coupled
- Diffraction-limited at  $\lambda=2.1$  mm

# Photometer Bands

- Atmospheric filtering important
- Notch Filters Required

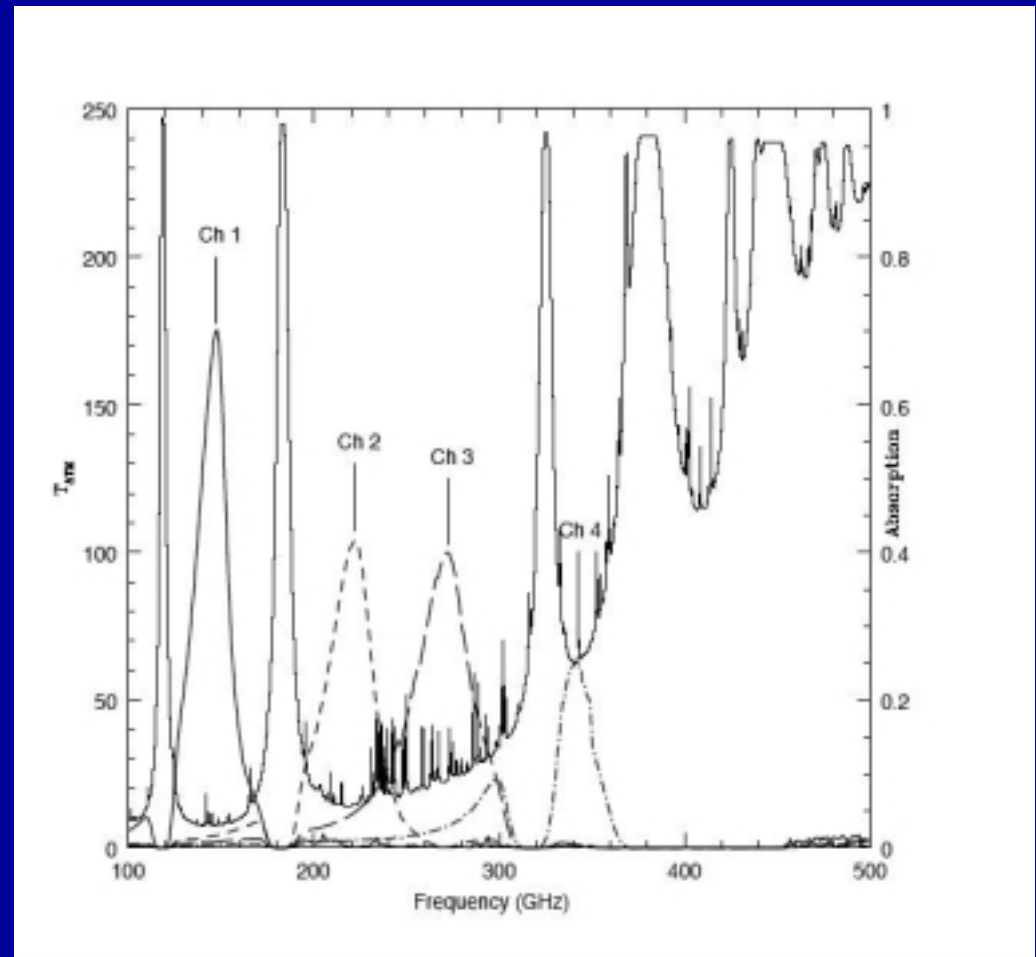

# Expected Performance

Band Center	Loading	G	BLIP	NEP
[GHz]	[pW]	[nW/K]	[aW/ $\sqrt{\text{Hz}}$ ]	[aW/ $\sqrt{\text{Hz}}$ ] 1
148	17	0.7	92	112
2 216	35	1.7	128	157
3 260	63	2.5	182	219
4 303	92	3.6	233	276

Notes: 1 aW=10<sup>-18</sup> W

T<sub>c</sub>~460mK

<sup>3</sup>He bath @ ~270mK

# Current Status

- Individual devices are being fabricated
- Cryostat to be delivered soon
- ‘Dark’ testing of samples underway

R(T) Curve

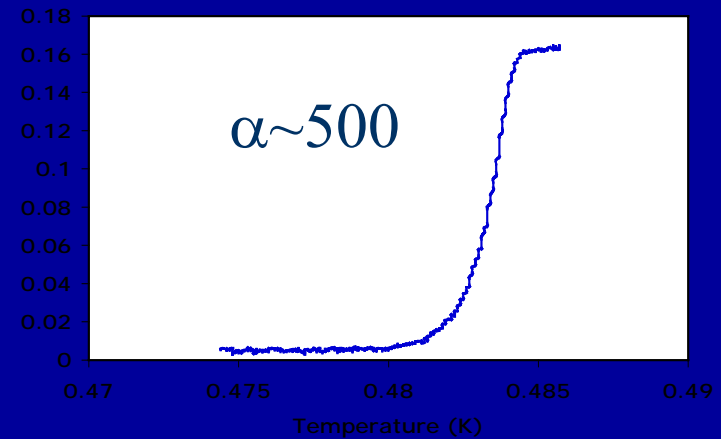

Load Curves

