

Understanding TES microcalorimeter noise and energy resolution



Wouter Bergmann Tiest
National Institute for Space Research
The Netherlands

Overview

- Numerical noise simulation
- Reduction of internal thermal fluctuation noise (ITFN)
- Responsivity model

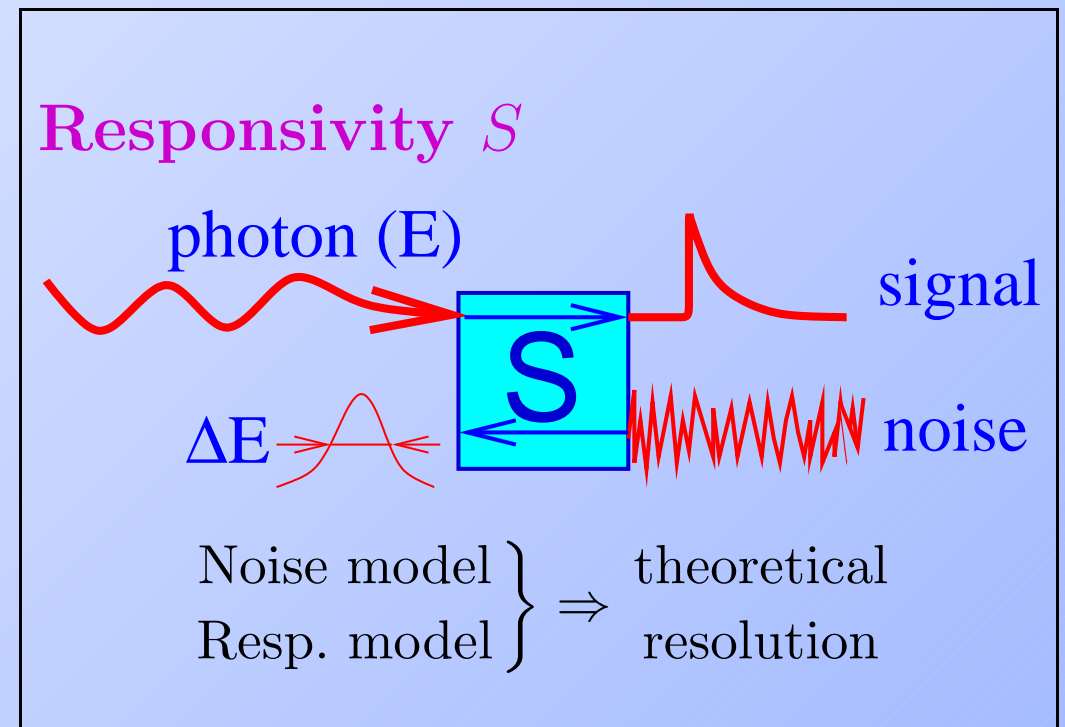

Noise model

Noise sources:

- **phonon noise** from link to bath
- **Johnson noise** from sensor resistance
- **internal thermal fluctuation noise (ITFN)** from internal thermal conduction

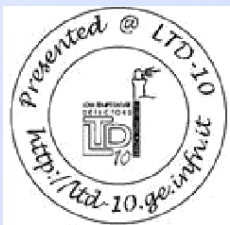
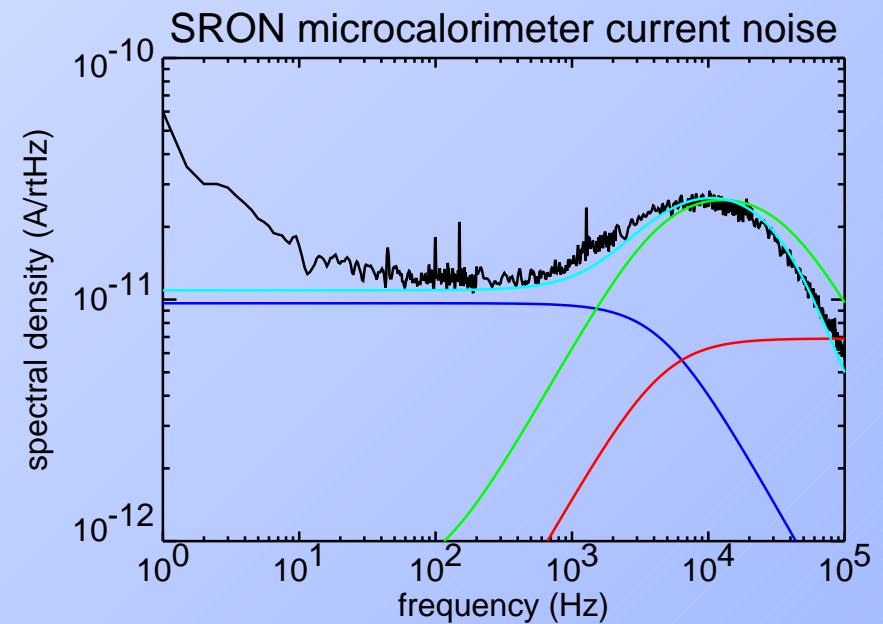
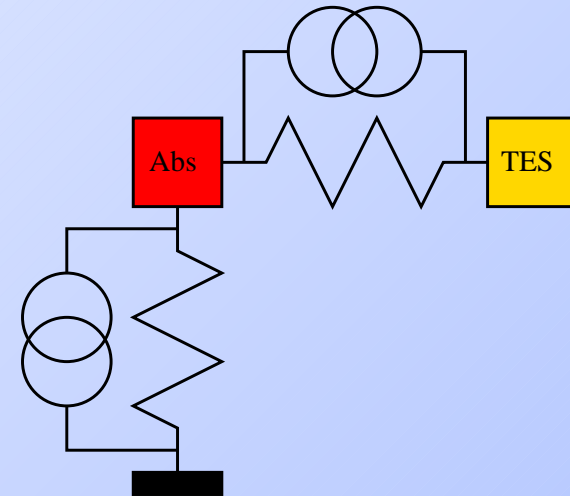

Numerical simulation with SaberTM

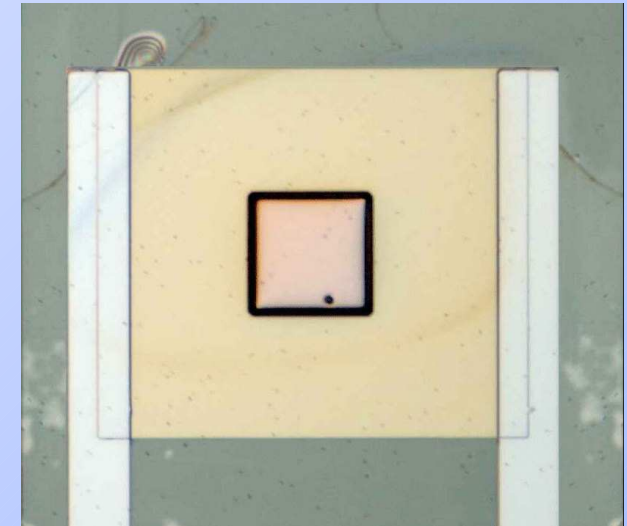
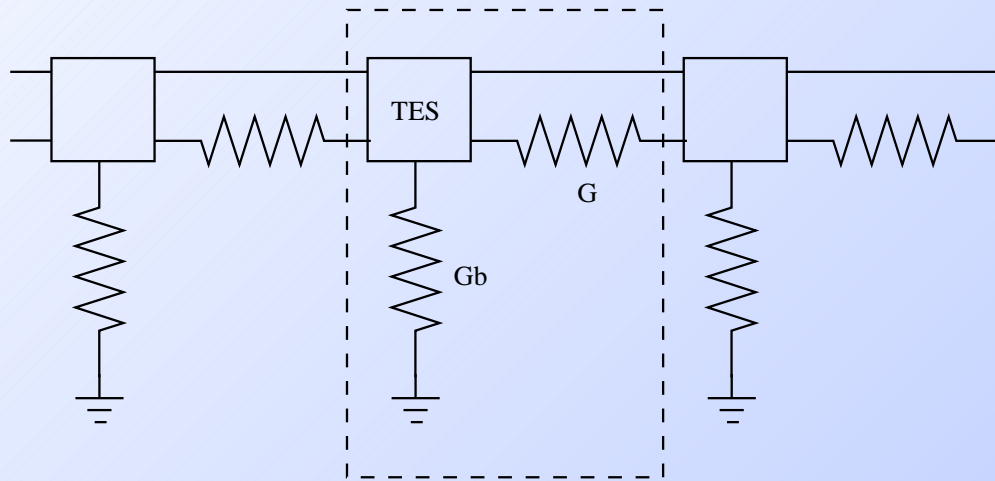

Simulation: ITFN visible through uneven

- heat capacity
- temperature sensitivity
- current density

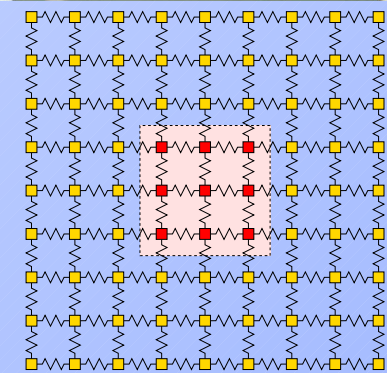

Segmented absorber

Normal metal bars reduce ITFN component

Experiment →

Simulation ↓

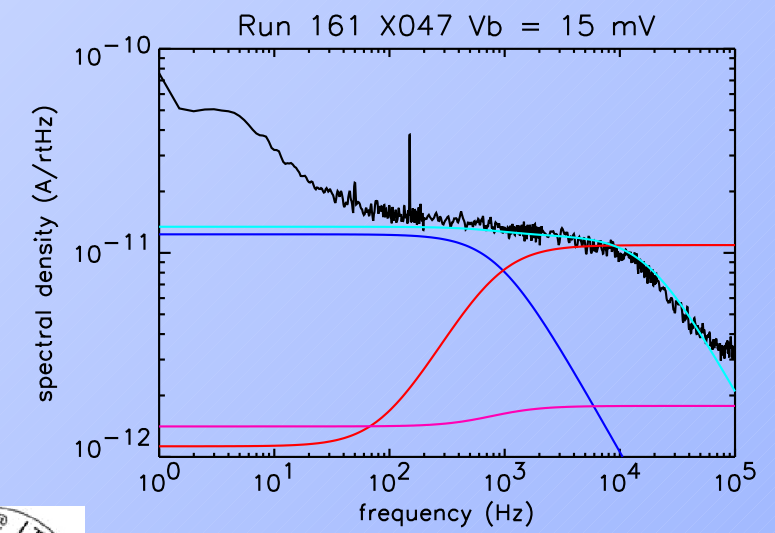
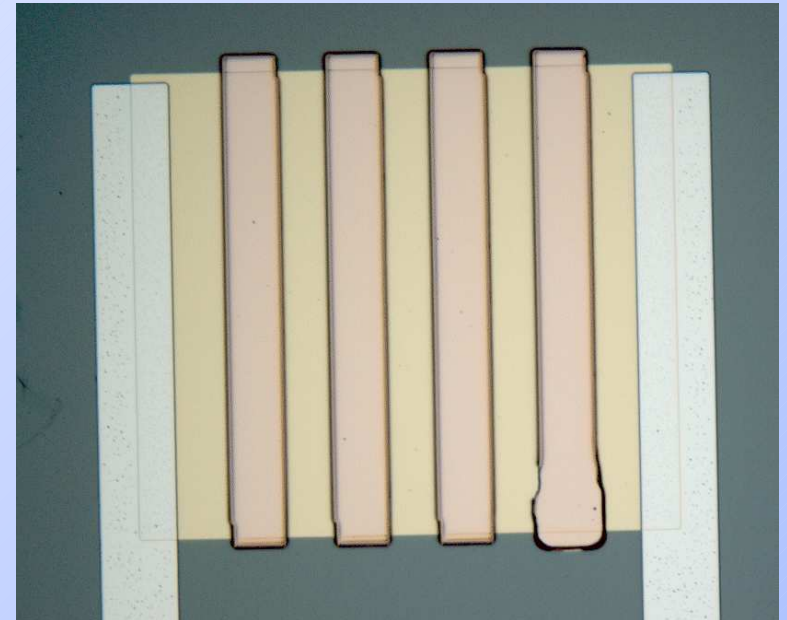
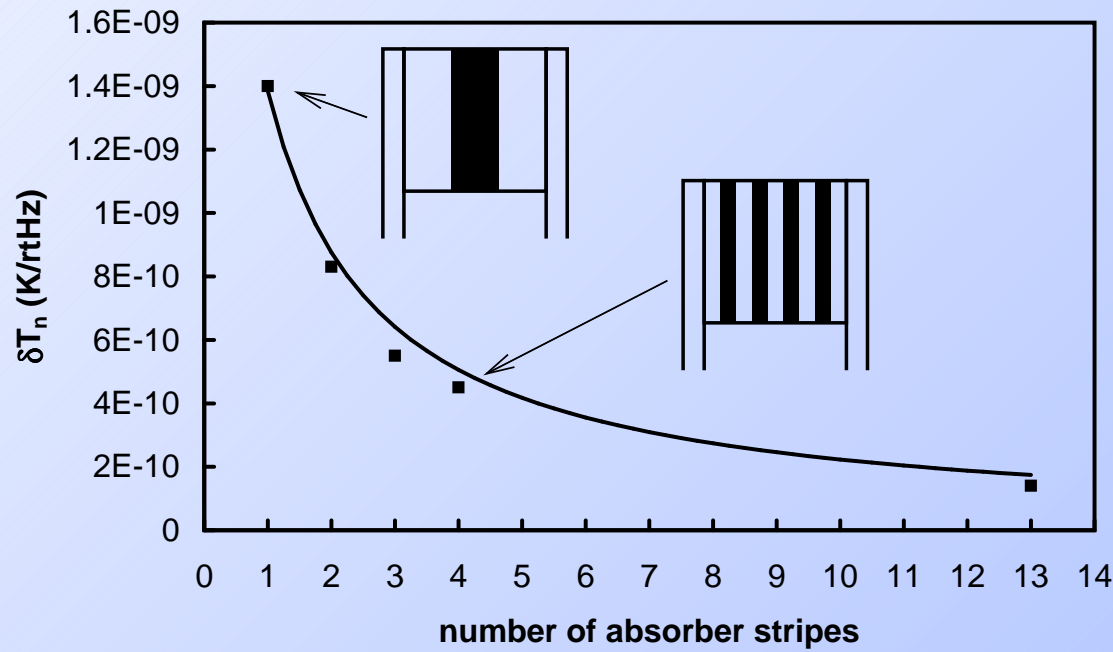

Stripe-dependence

Stripes: local heat baths

$$f = \frac{G}{2\pi C} = (4n + 2)^2 \frac{G_{TES}}{2\pi C_{TES}}$$

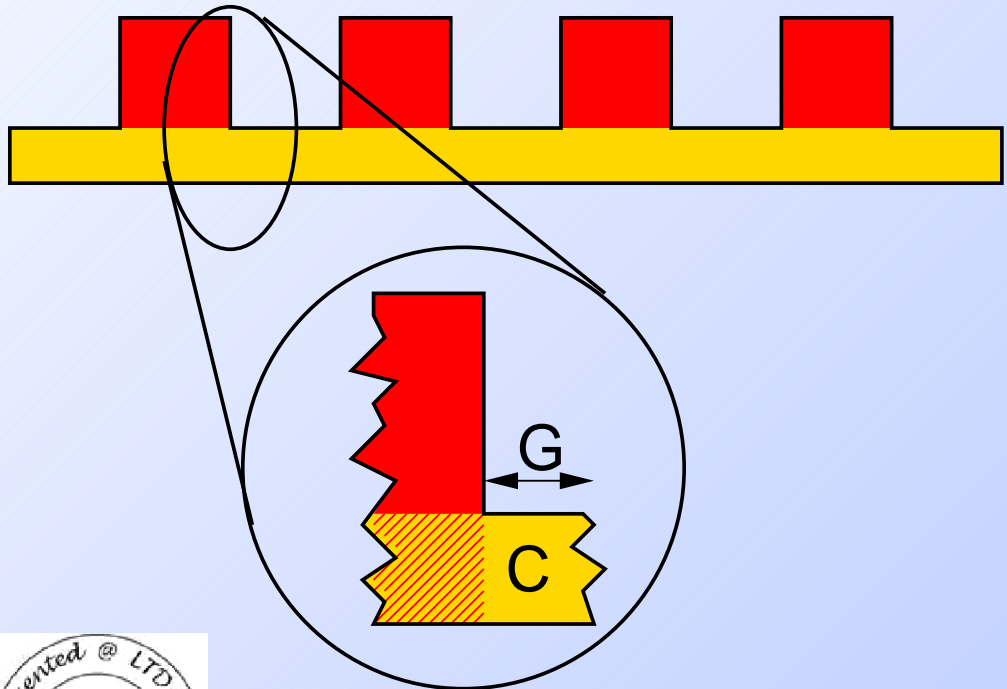

Higher bandwidth \Rightarrow lower level

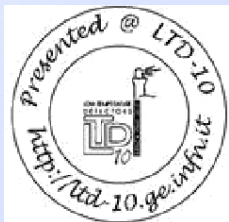
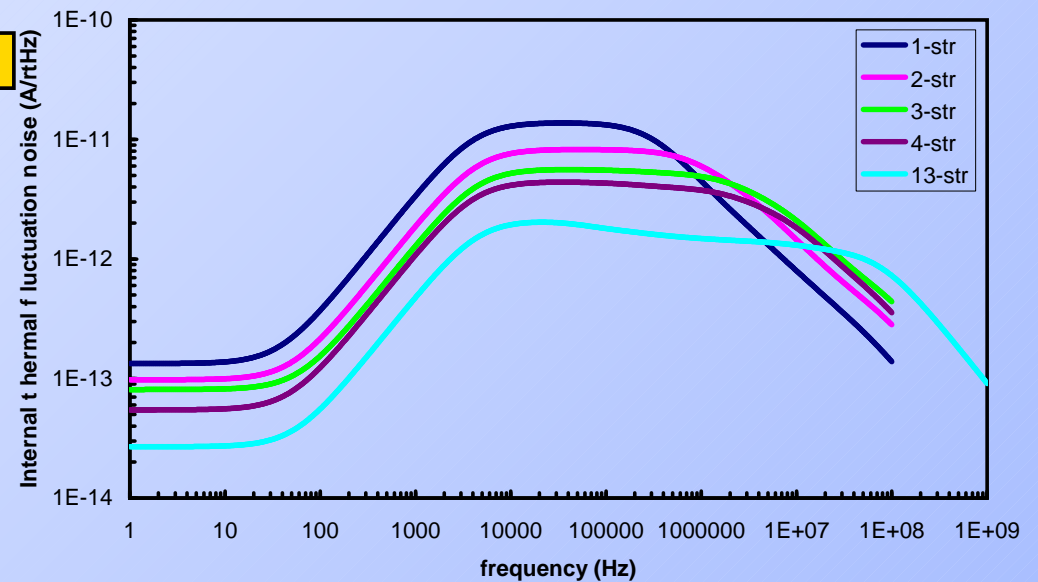

$$C = \frac{C_{TES}}{4n + 2}$$

$$G = (4n + 2)G_{TES}$$

$$\delta T_n = \sqrt{\frac{1}{(n + 1)(2n + 1)} \frac{k_B T^2}{G_{TES}}}$$

Responsivity model



Pulse shape: **Small signal** (analytical):

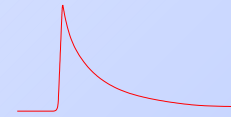

Large signal (numerical simulation):

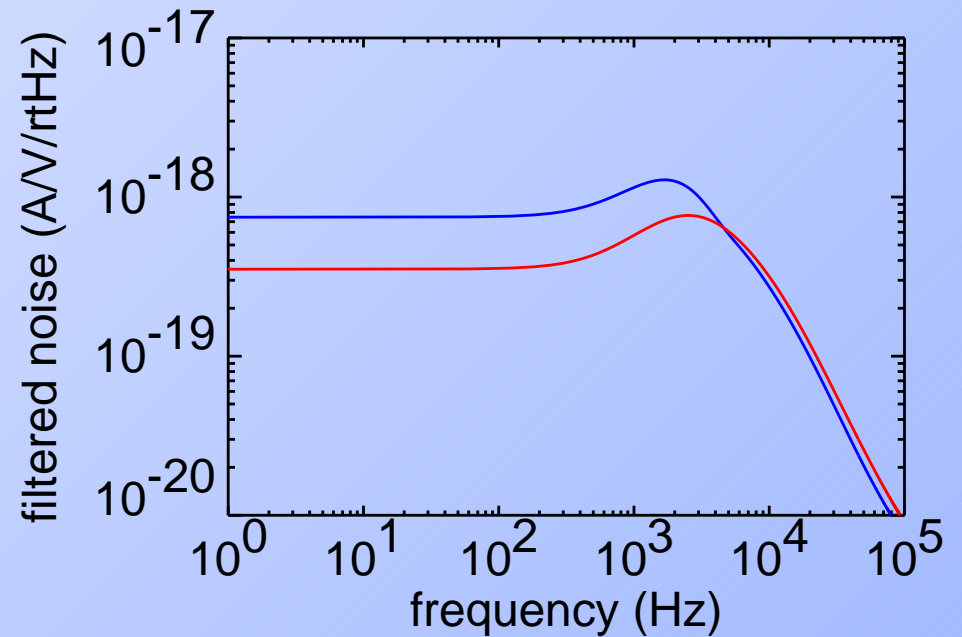
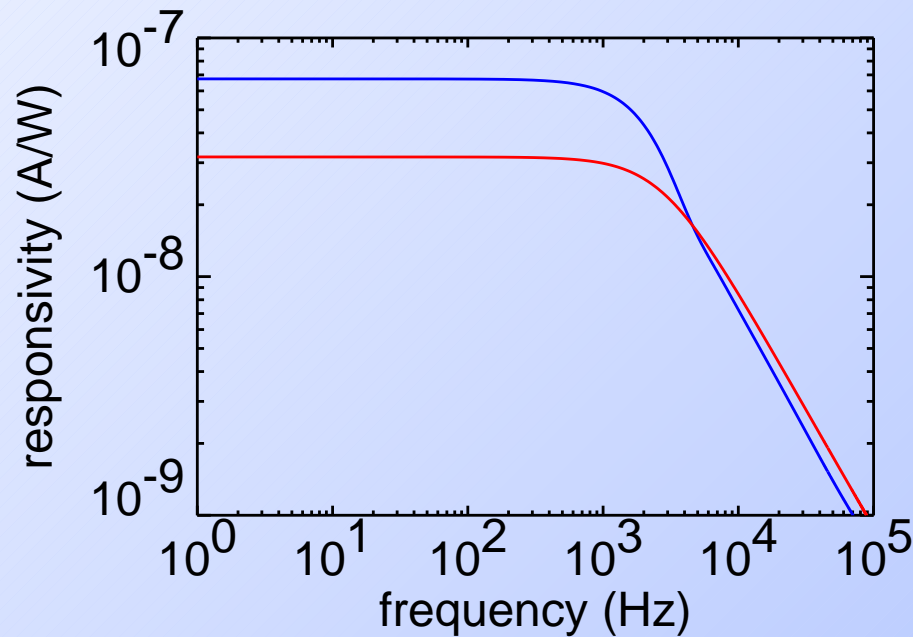
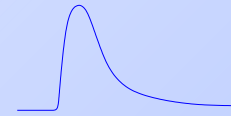

Resolution calculation



- Measured noise spectrum
- Responsivity: FFT of measured pulse shape

Device	Measured (eV)	Calculated (eV)	
		SS	LS
X037-2	4.2	2.1	4.4
X038	4.1	1.5	4.3
X043	4.7	3.0	3.9
X047	15.7	1.9	15.8
X049	5.3	2.4	4.7
X055-6	4.5	1.3	3.3

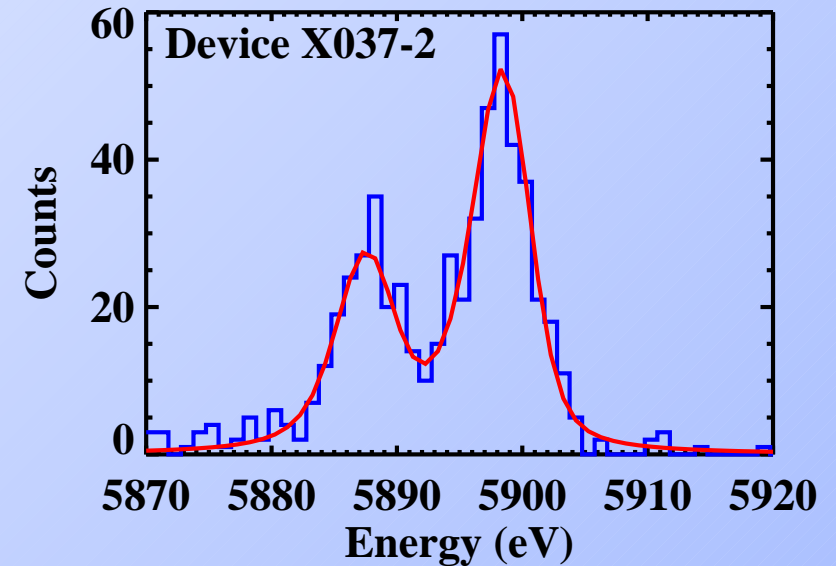

Agreement generally better than 1 eV (< 20%)

Conclusions



- Numerical simulation successful
- Geometry dependence internal thermal fluctuation noise understood
- Responsivity model more realistic
- \Rightarrow Measured resolution understood
- Resolution improvement should be possible with segmented absorber