

High-Resolution Gamma-Ray and Neutron Detectors For Nuclear Spectroscopy



Thomas Niedermayr, I. D. Hau, S. Terracol,
T. Miyazaki, S. E. Labov and S. Friedrich
Former colleagues: M. F. Cunningham, J. N. Ullom



Lawrence Livermore National Laboratory, CA, U.S.A.

A. Burger



Fisk University, TN, U.S.A.

Z. W. Bell, V. E. Lamberti

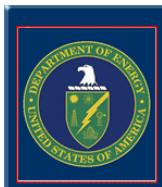

Y-12 National Security Complex, TN, U.S.A.



Composite Microcalorimeter Spectrometer

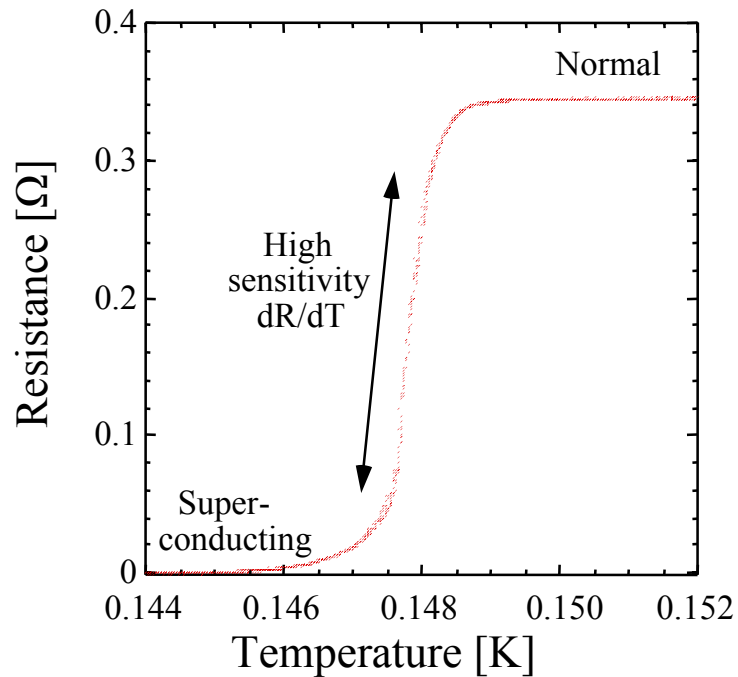
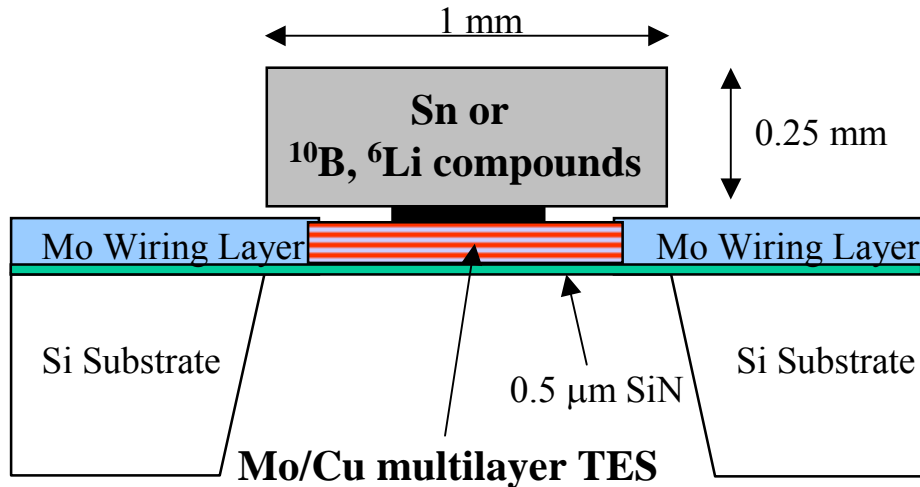

2 stage ADR
6-8 hours operation below T_c

Frequency-Domain Multiplexing

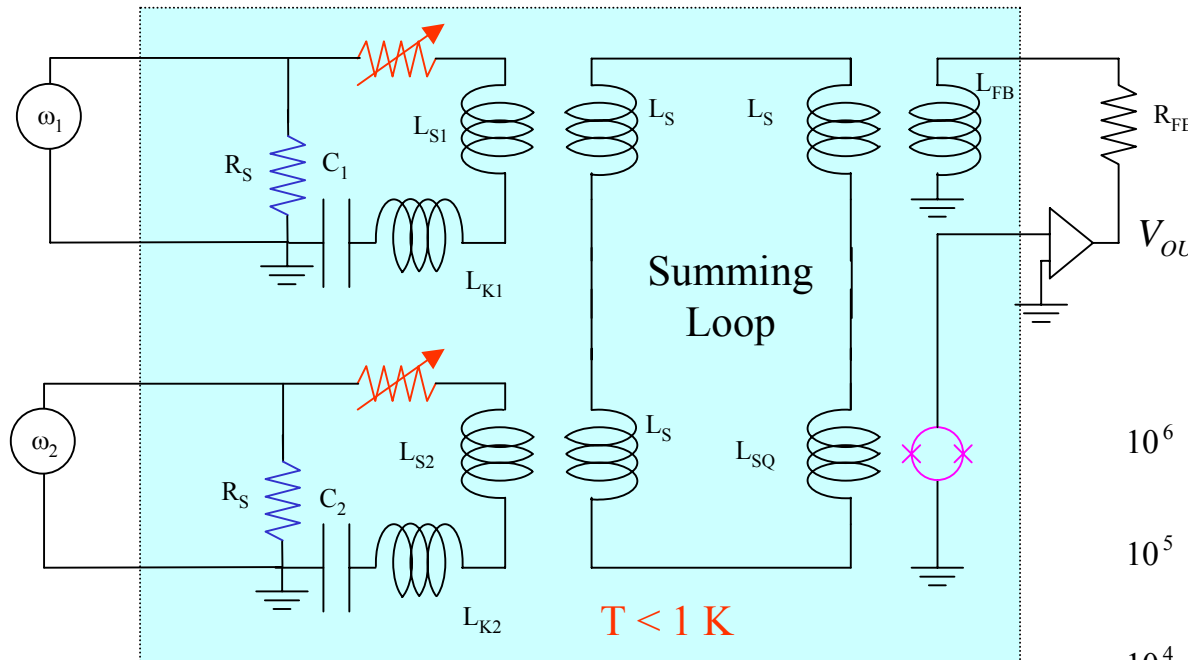

$$V_{OUT}(\omega) = \frac{A_1}{1 + (\omega - \omega_1)^2 \tau^2} + \frac{A_2}{1 + (\omega - \omega_2)^2 \tau^2}$$

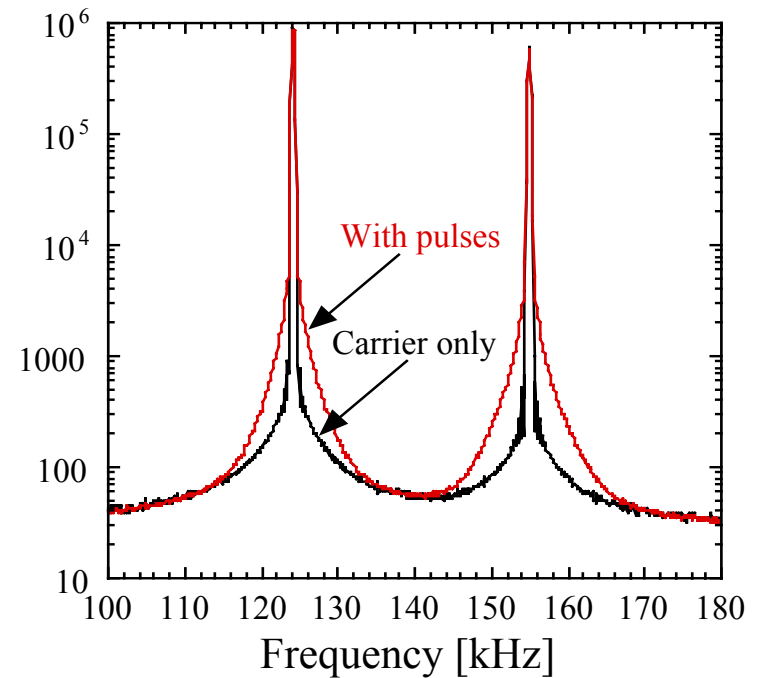

Sum signals from 2 sensors with summing loop
 Readout 2 sensors with one SQUID amplifier
 Demodulate output with lock-in amplifiers
 Scalable to n $\text{\textcircled{7}}$ 2

DC and AC Comparison



Current Pulse (Time)

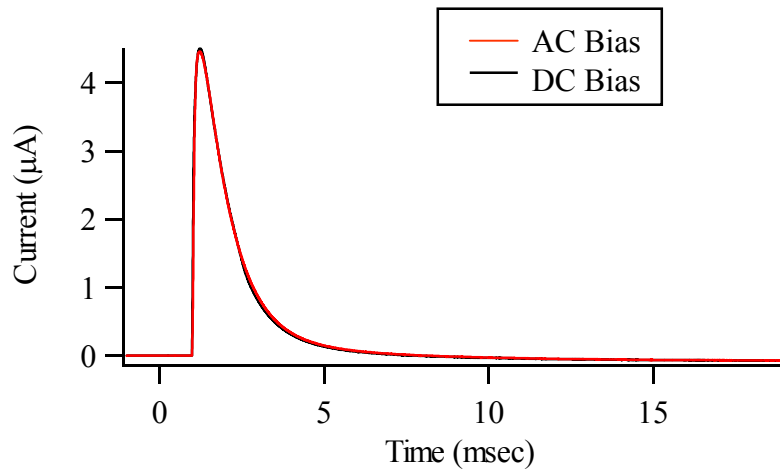

DC and demodulated AC pulse shapes are identical

Current Pulse (Frequency)

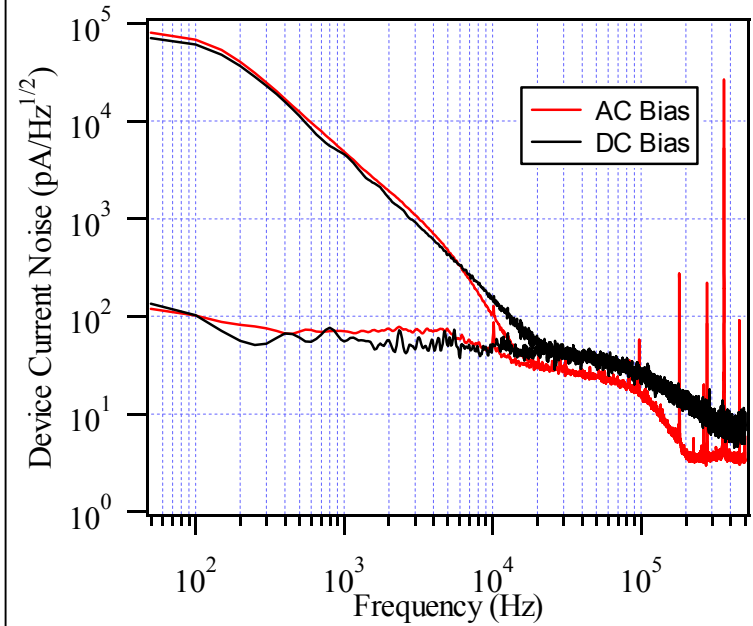

LC resonant circuit acts as a filter for AC Biased Data

Demonstrated $\Delta E_{FWHM} = 60$ eV at 60 keV for 2 multiplexed detectors, same as DC case

γ -ray Spectrum of a Mixed Pu Isotope Source



Determination of Pu Isotopes Abundances

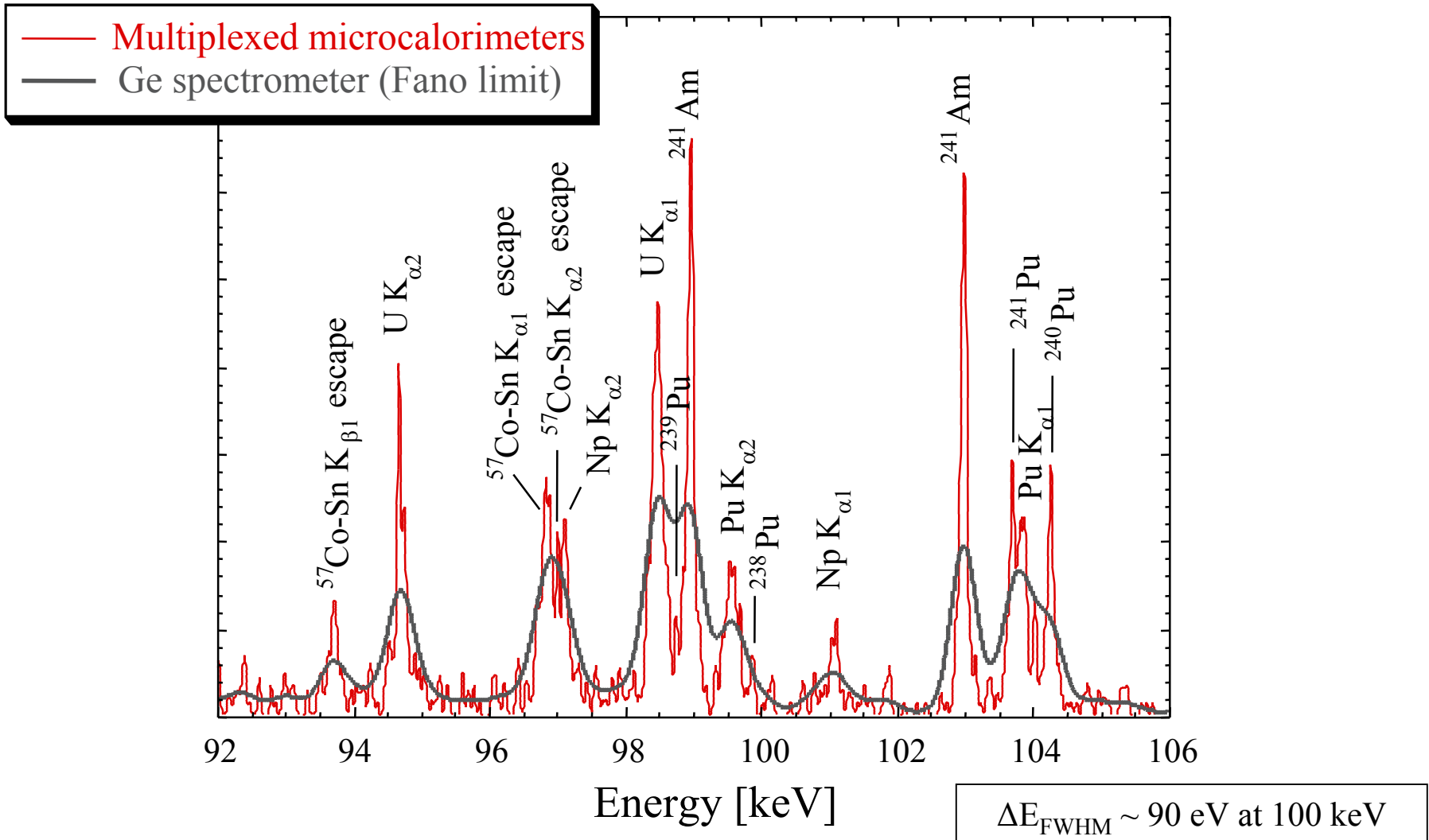

Fast-Neutron Spectrometer

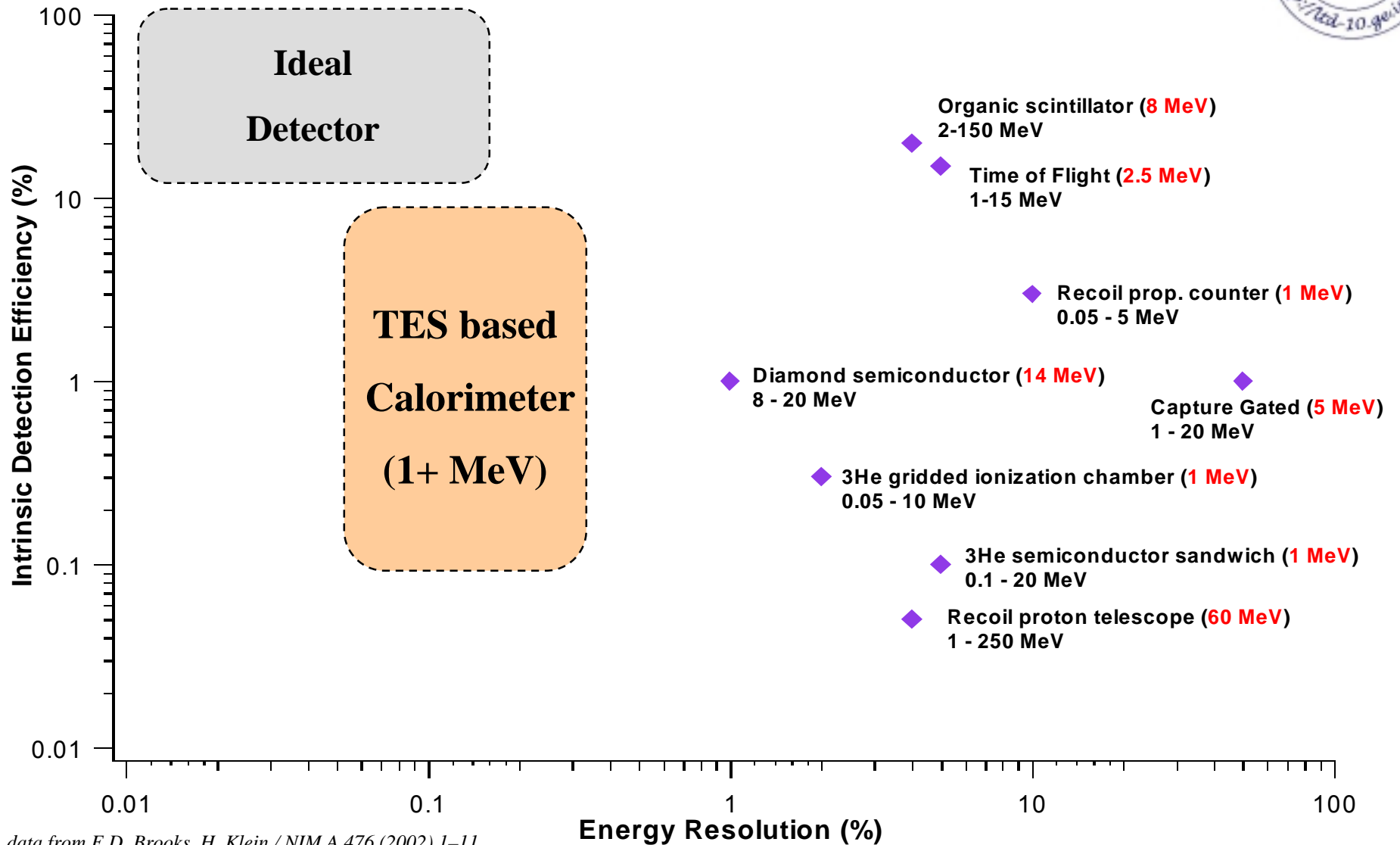

data from F.D. Brooks, H. Klein / NIM A 476 (2002) 1-11

Neutron Transmission Spectroscopy



MCNP simulation of the neutron emission spectrum from Pu and PuO₂

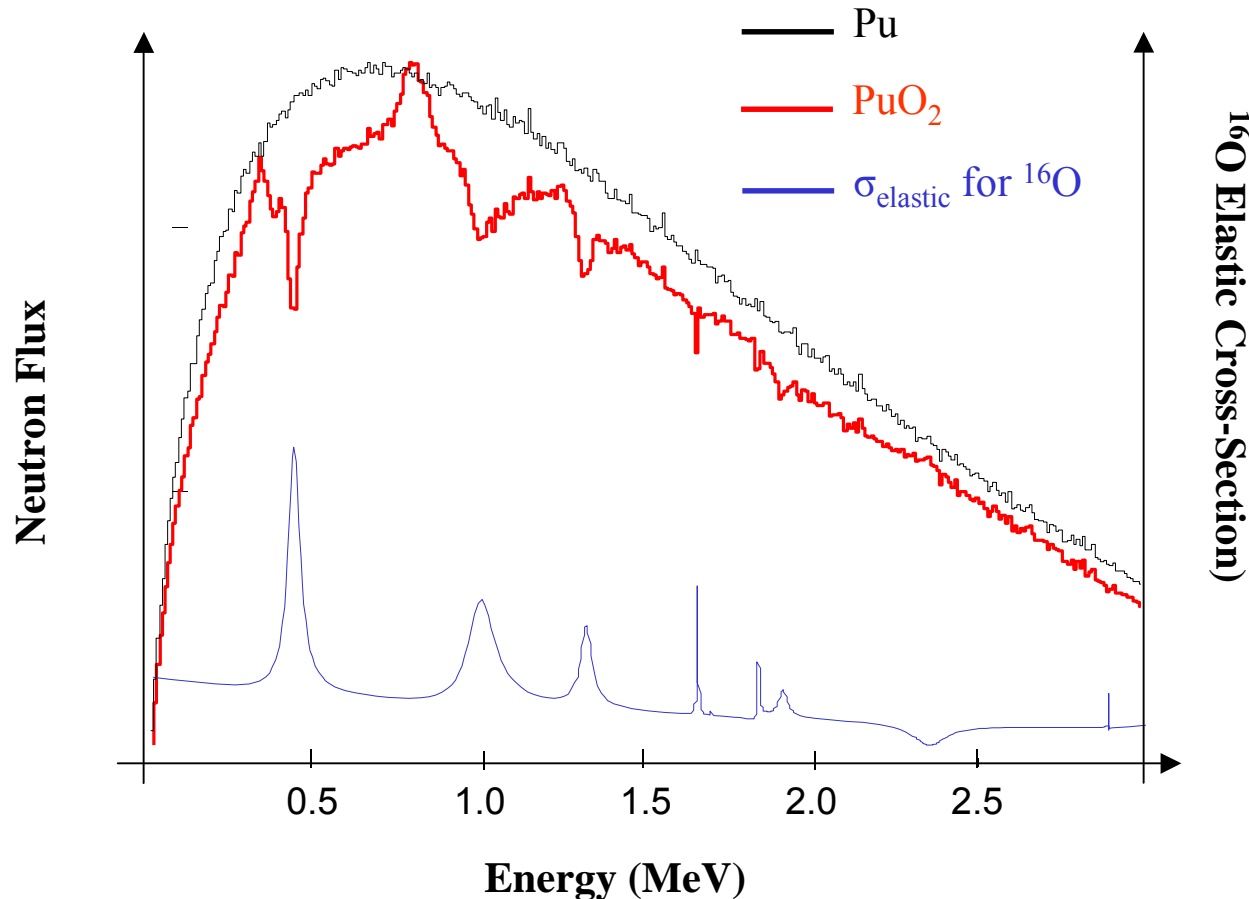

Active or passive interrogation for elemental composition analysis
Advantages: large penetration depth and nondestructive

Neutron Detection Principle



- Choose absorber material with high (n, α) cross section
- After neutron capture:

Heavy charged particles are created and stopped in the absorber

$$E_{\text{deposited}} = Q_{\text{reaction}} + E_{\text{neutron}}$$

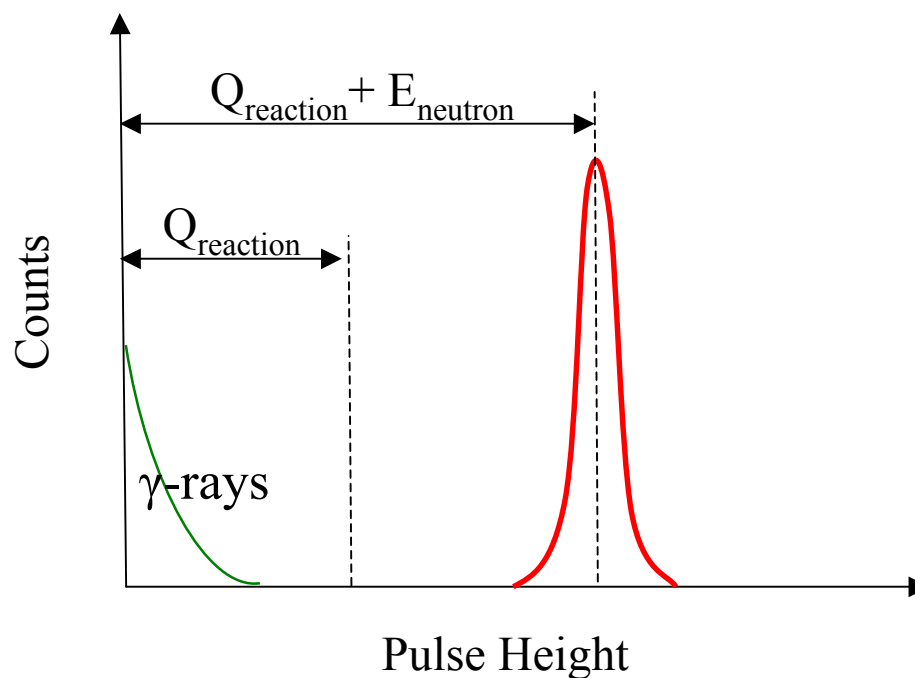

Photons with $E_{\gamma} < Q_{\text{reaction}}$ can be discriminated against neutrons

Neutron detection materials



^{10}B

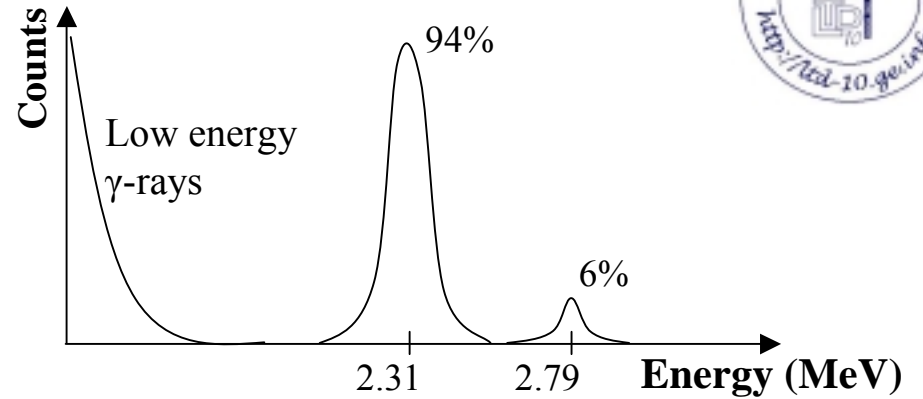
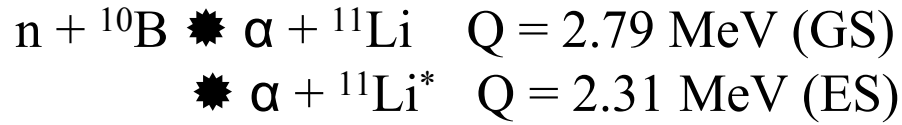

^6Li

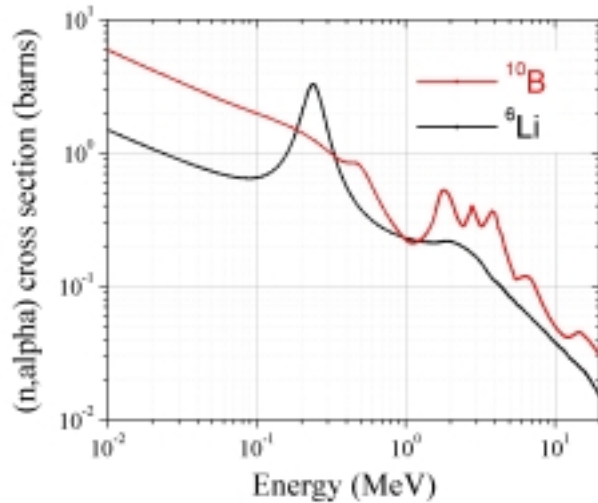
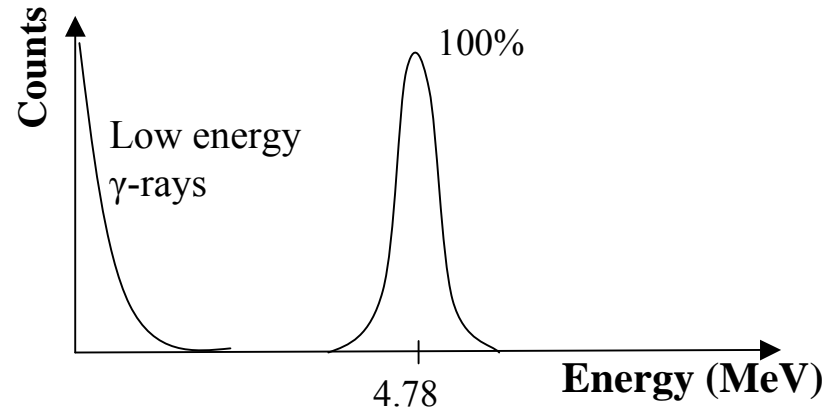

Expected spectrum for thermal neutrons

First neutron spectrum



TiB₂ absorber for neutron detection:
large heat capacity per unit mass (metal)

$$C_{\text{absorber}} = 10 \text{ nJ/K}$$

$$m_{\text{abs}} = 4 \text{ mg}$$

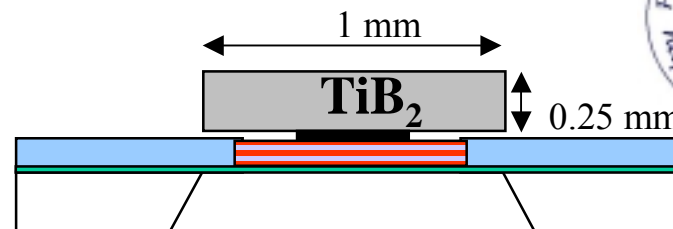

Thermal neutrons spectrum

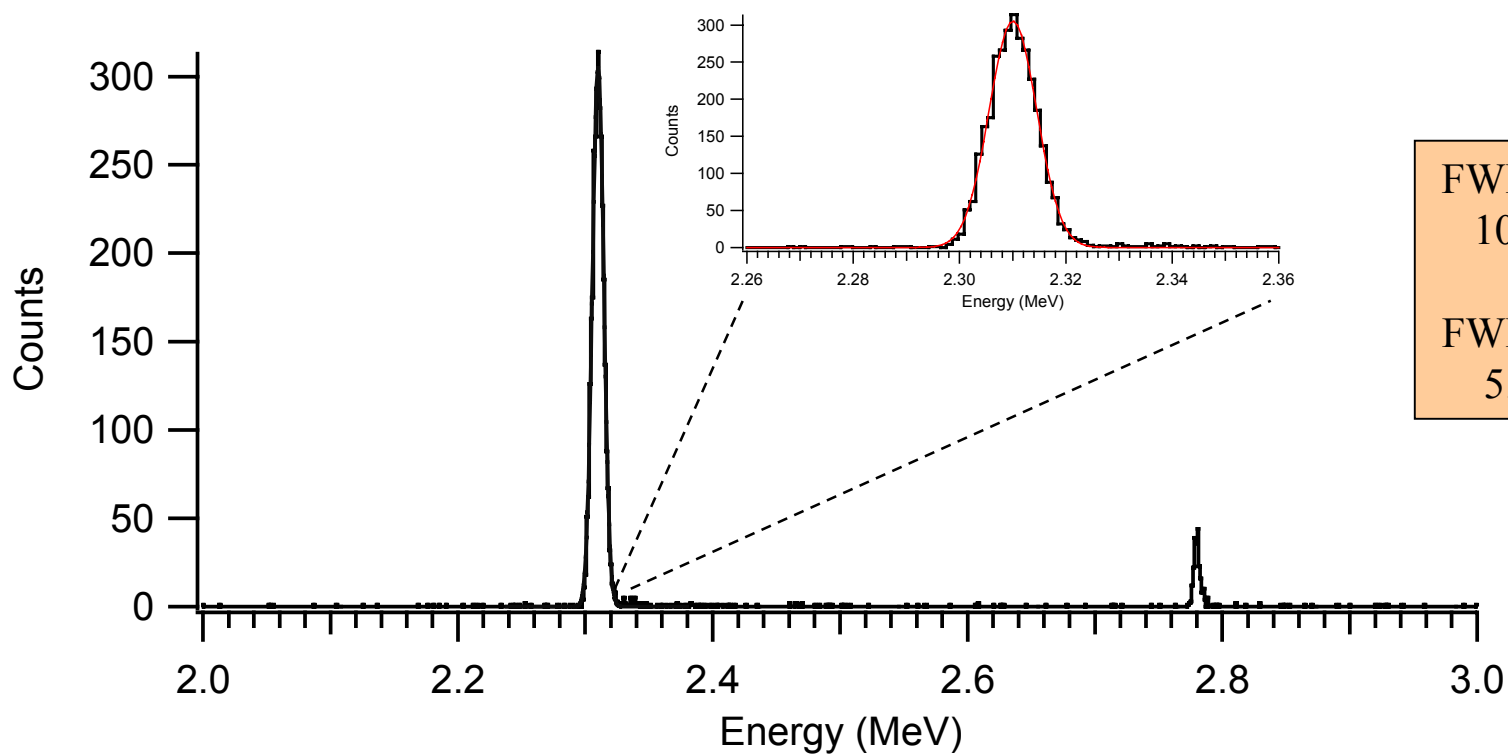

Large absorber design

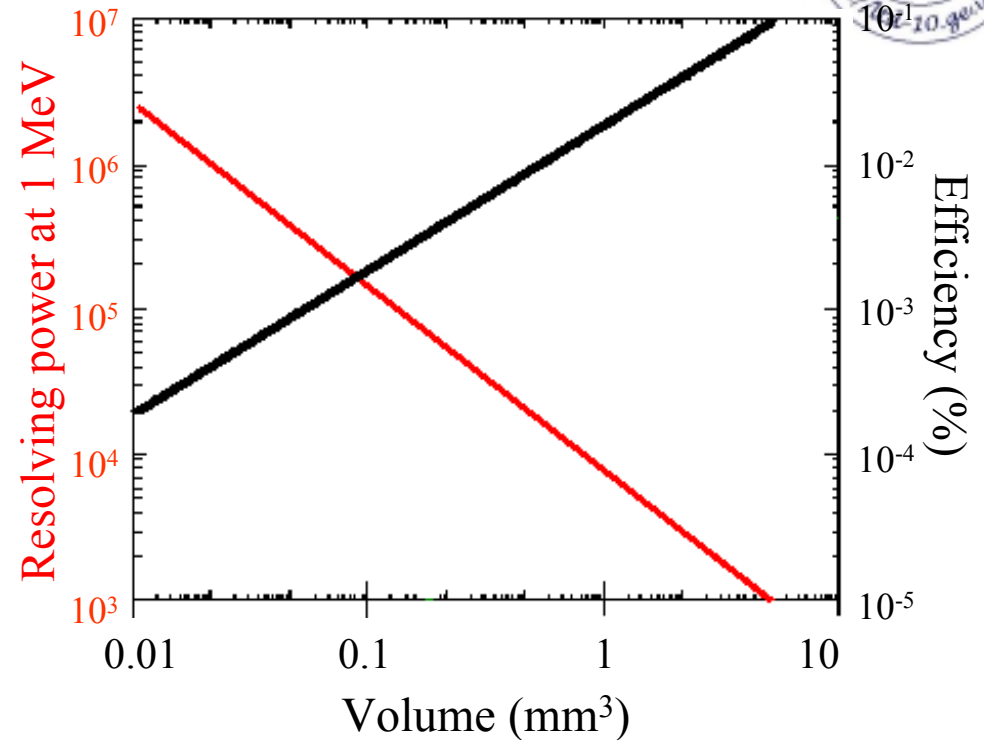
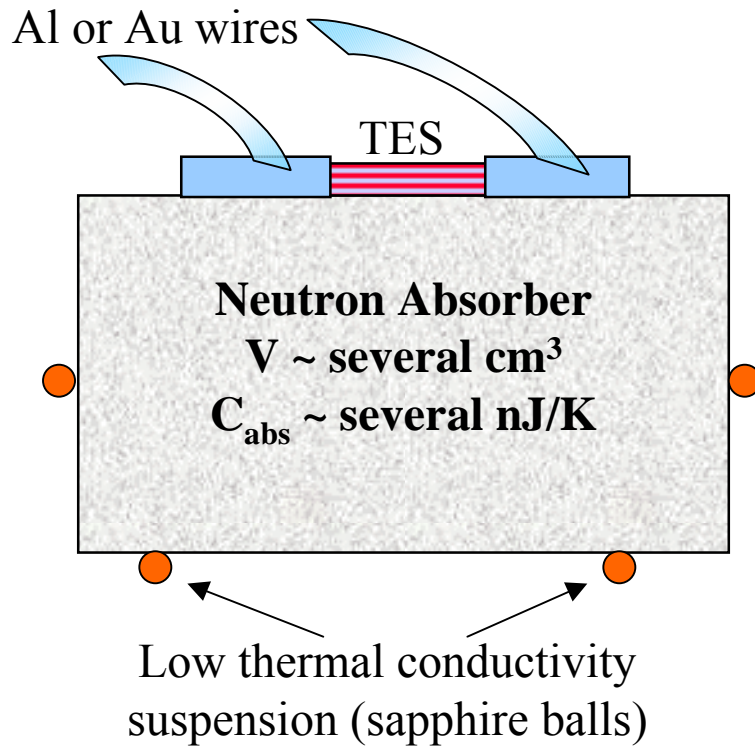

Size will be adjusted for particular application:

- Max. count rate capability limits maximum size of each individual pixel
- Source strength sets number of pixels to multiplex

Summary



High resolution γ spectroscopy with multiplexed detectors

✱0.1% FWHM energy resolution at 100 keV

High resolution neutron spectroscopy

✱0.2% FWHM energy resolution at 2.79 MeV