



# Sandro Vitale (1932-2001)

**"Presently, I am interested in  
Josephson tunnel detectors  
for low energy spectroscopy »**

**March 1983 (registration to LTD zero)**



Detection of environmental fine structure  
in the low-energy  $\beta$  decay spectrum of  
 $^{187}\text{Re}$ , **F. Gatti, F. Fontanelli,  
M. Galeazzi, A. M. Swift, S. Vitale,**  
*Nature* 397 (**1999**) 137-139.

# Tentative Prehistory of Low Temperature Detectors

Georges WAYSAND

Groupe de **Physique des Solides** Univ.  
Paris 6 & 7

+ **Laboratoire Souterrain Bas Bruit** Rustrel-  
Pays d'Apt

Univ. Avignon et Pays du Vaucluse



# Acknowledgments :

**N. Coron**

**V.L. Ginzburg**

**T.A. Girard**

**C. Glasshauser**

**N. Kurti**

**J.M. Kantor**

**P. de Marcillac**

**M. Ribeiro Gomes**

**and**

**Jean Matricon**

**Orsay**

**Lebedev**

**Lisboa**

**Rutgers & Livingston**

**Oxford**

**Math Paris7**

**Orsay**

**Lisboa**

**GPS- Paris7 co-author of :**

***Cold Wars : A History of Superconductivity***

**(Rutgers University Press, August 2003)**



# Act I

# 25 June 1903 : Marie Curie thesis

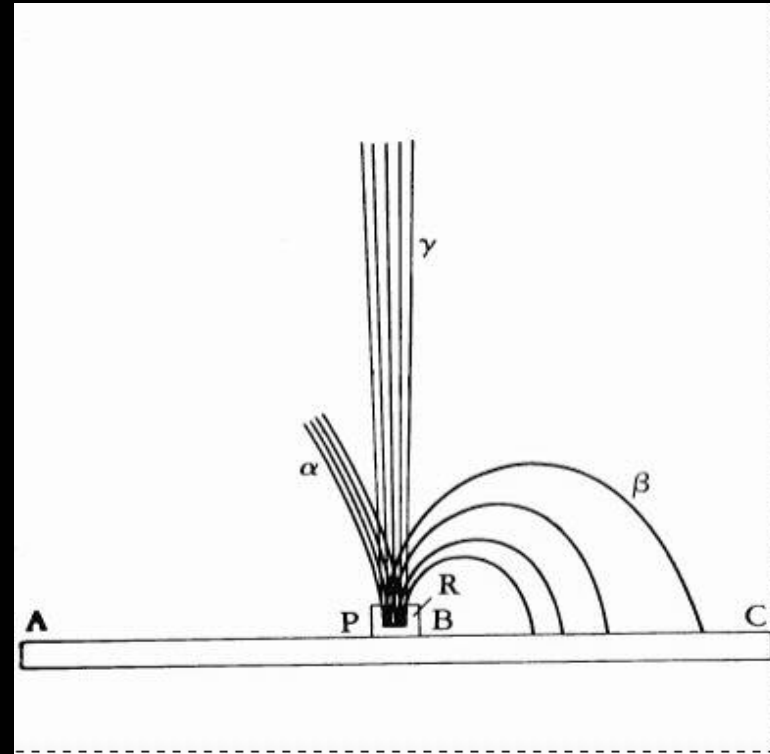

- «But for Rutherford and the Curies ...alpha rays remained a mystery»
- (E.Segrè, *From X-rays to Quarks* 1980)

# Rutherford and Soddy a year before:

- "...the speculation naturally arises whether the presence of helium in minerals and its invariable association with uranium and thorium, may not be connected with their

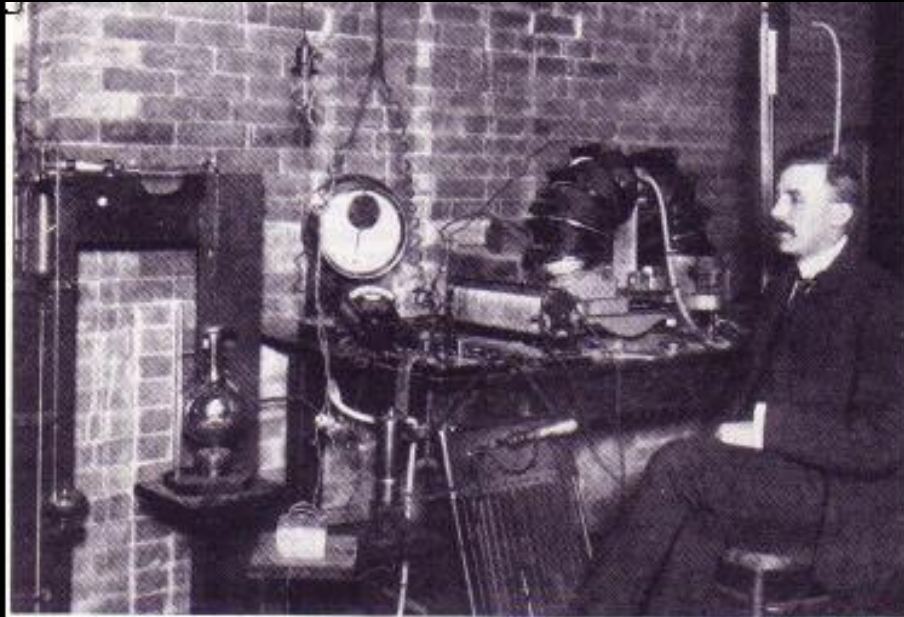
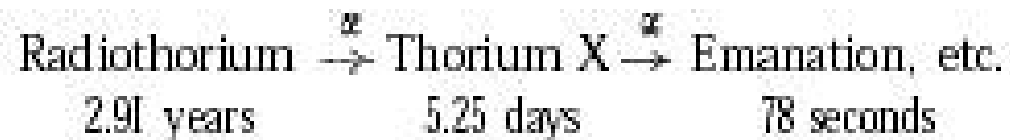

Figure 3.4 Rutherford at McGill University, Montreal, in 1905. In this year he began research on the properties of  $\alpha$  particles. Their scattering later led him to the discovery of a heavy nucleus in the atom. (From Eve, *Rutherford*.)

# And in 1903 again

- ... possibly helium is an ultimate product of the disintegration of one of the radioactive elements, since it is only found in radioactive minerals

## 1907



Soddy (Nobel lecture 1921)

## And so on .....



**Emanations, alpha rays,  
Helium ,  
birthplace of the splitting of  
physics :**



Ramsay : Optical spectroscopy **⇒** **periodic table**

Rutherford, Geiger : mass spectroscopy **⇒** **nuclear physics**  
Soddy

Dewar, Kammerlingh Onnes :liquefaction **⇒** **Low temp.**

# James Dewar

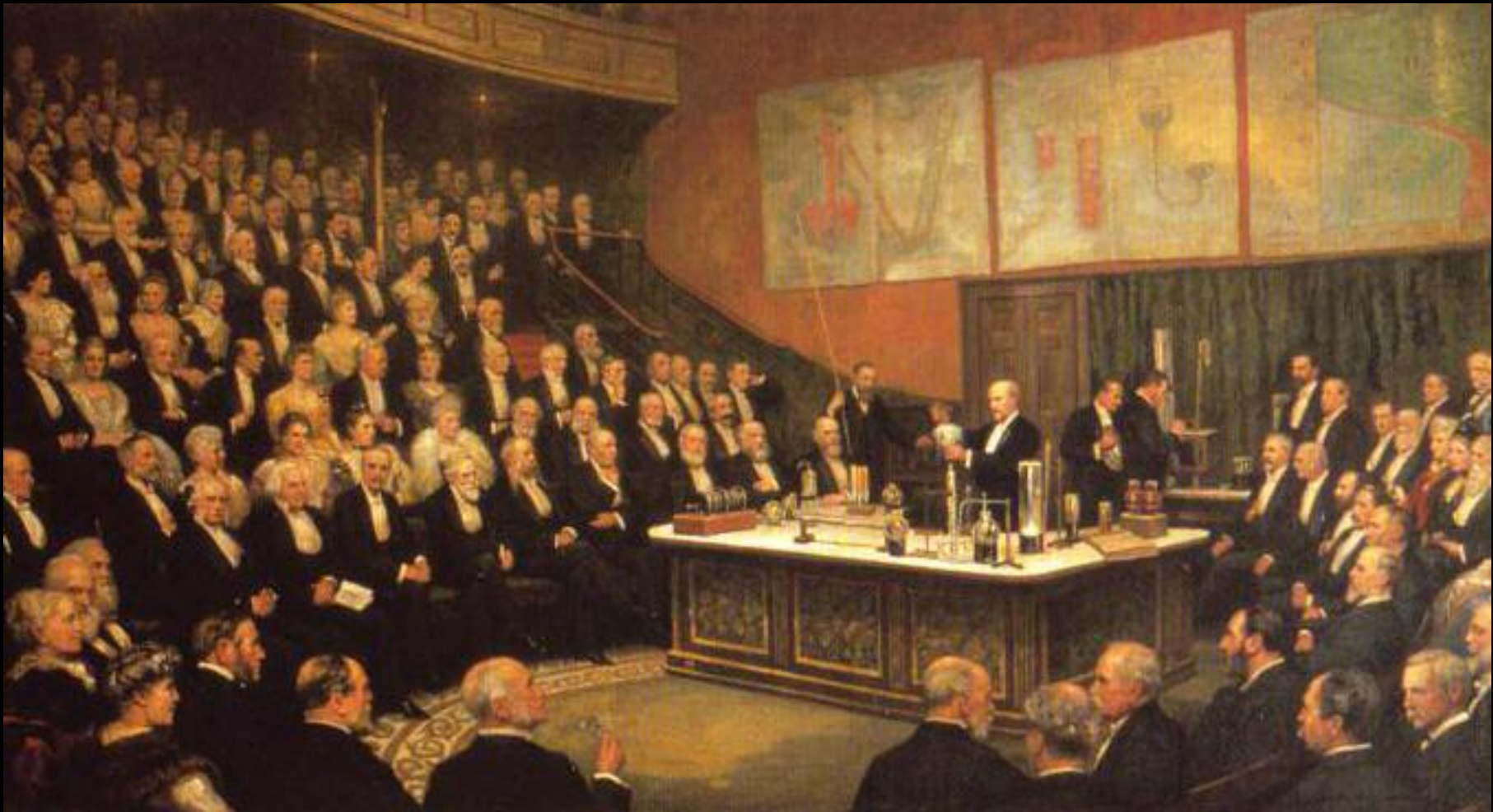

**The cryostat show**

# Kammerlingh Ones

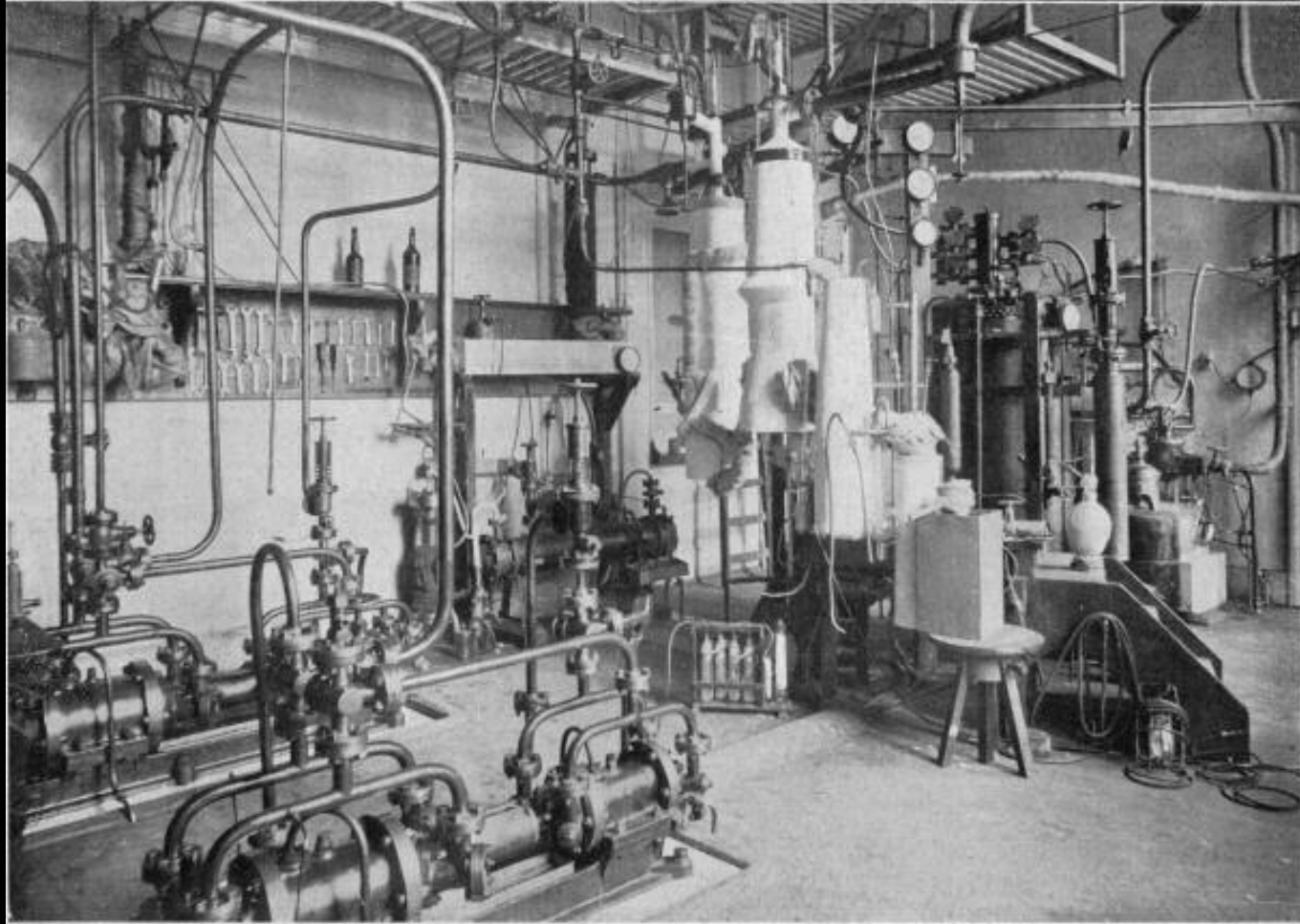

**Industry applied to Science !**



**Solvay Council 1911**



# Act II



# Late Twenties and Thirties :

## Golden Age in Physics...

L.Gurevitch  
L.Landau  
L.Rosenkevitch  
A.Arsenieva  
Ya.Frenkel  
G.Gamow  
M.Manchinskii  
D.Ivanenko  
G.Mandel



Emanations = radon

Alpha rays ← tunnel effect

Neutron, positron etc...



## .... Thirties

### *Dark times for Societies :*



An important event in the history of the Clarendon was Hitler 's coming to power in Germany in 1933 which resulted in an influx of German academic refugees....

*N.Kurti*



**In Soviet Union (among others):**  
**First row: Shubnikov (shot in 38) Leipunski (jailed),**  
**Landau(jailed), Kapitza(could not returned to UK)**



**Kharkov 1934**





# **At the end of the thirties a double movement has occurred:**

- > From one field of physics to another  
from nuclear to LT( Kapitza)  
from solid state to nuclear (Kurchatov)**
- > Deep modification of the geographical  
repartition of scientists in Europe and  
from Europe to the US.**



## **Consequences in LTD :**

**> First low temperature detection by Kurti  
in Oxford:  
1,5g radium near adiabatic demagnetization  
cryostat !**

**> Superfluidity of Helium  
...in Moscow  
by Kapitza, because of Stalin  
... in Cambridge  
by Allen & Misener, in spite of Stalin**



## **Just before WWII:**

**>First «naïve» suggestions of  
superconducting bolometers :**

**A.Goetz Phys. Rev. 55, 1270 (1939)**

**>just a few cryogenic centers**



# Act III

**A New Knot Between  
Particle, Cosmology  
and  
Low Temp Physics**



# A new knot between Cosmology Particle and Low Temp Physics :

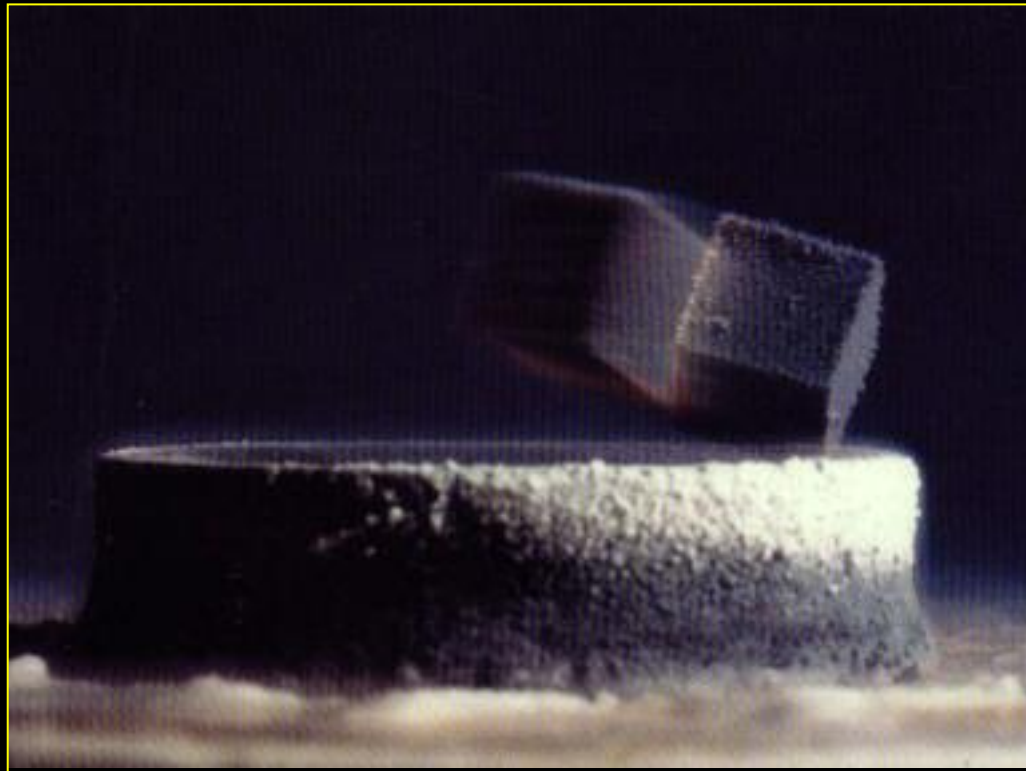



## *Experiments :*

**Isotope effect** > electron-phonon interaction

**Tunnel effect** > energy gap direct read-out

## *Theoretical Tools and Concepts:*

**Field Theory**

**The notion of Pairing**

**Many body problem**

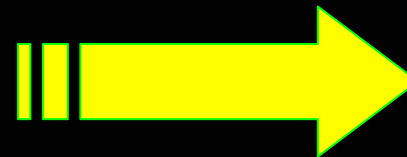



**B.**



**C.**



**S.**



**More elegantly treated by Gork'hov  
...following Bogolioubov  
gave **



# > Physical meaning to the phase of the wave function .



**Brian Josephson**  
(1963, Mond)

> Analogy of the vacuum of the Standard Model with the electromagnetic vacuum inside a superconductor (broken symmetries and phase transition *à la* Ginzburg-Landau).

> neutron stars





## **+** potential applications :

**> transition curves**

**> superheated superconducting grains**

**> spatial modulation of the order  
parameter = quasi particle traps**

**> Josephson devices**





# Act IV

## Cosmic Microwave Background and Infrared Astronomy

**During the late 1950's, H. E. D. Scovil and his associates at Bell Labs were building the world's lowest-noise microwave amplifiers, ruby travelling-wave masers. These amplifiers were cooled to 4.2 K or less by liquid helium**



**20-foot horn-reflector used by Penzias & Wilson**



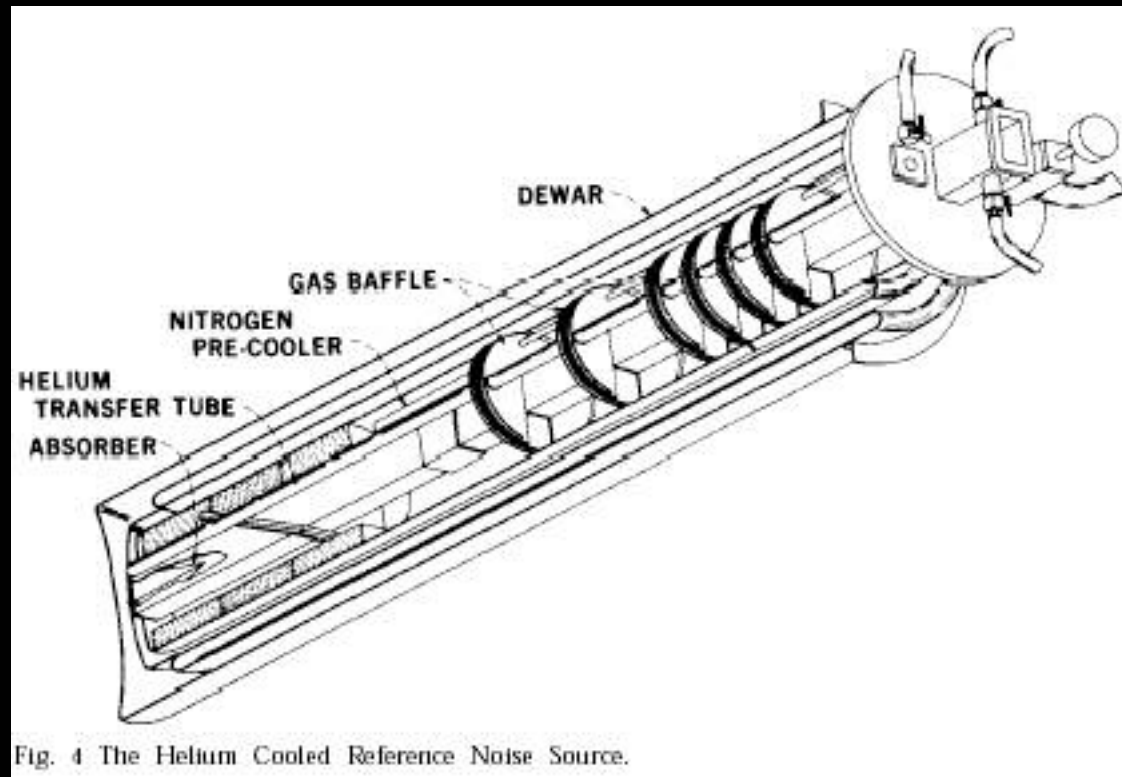

Fig. 4 The Helium Cooled Reference Noise Source.

## 4.2K Noise Source



**3K black body CMB by Penzias & Wilson**



# Infrared spectroscopy was already existing

**F.D.Low**

Temperature = 2 °K

Area = 1 x 1 mm

Focal Ratio = f/15

Wavelength = 7 - 14 microns

Background Power,  $Q = 2 \times 10^{-7}$  watts

$G = 1 \times 10^{-6}$  watt/°K

NEP =  $3 \times 10^{-14}$  watt/Hz<sup>1/2</sup>

Chopping Frequency = 20 Hz



# F.D.Low april 1969

The questions arise : “What of the future ?“ ;  
As detector sensitivity increases through future developments, can we expect an ever increasing observational sensitivity? It is clear that the answer is negative unless the background power can be reduced {...}

By refrigerating the entire telescope and placing it in space, it should be possible to extend The observational capability by several orders of magnitude.



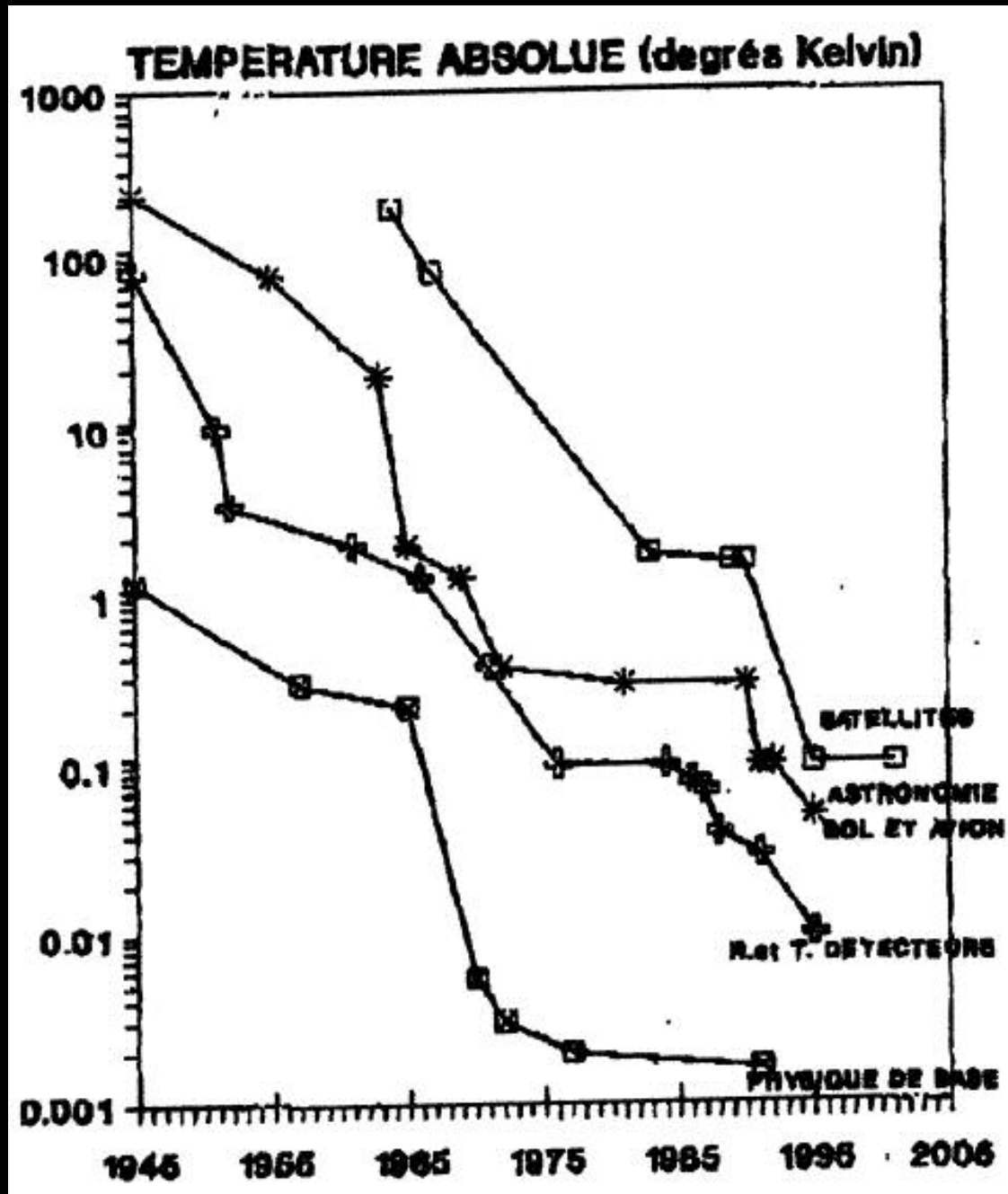

**CMB over half a century has been  
the main driving force for LTD s.**

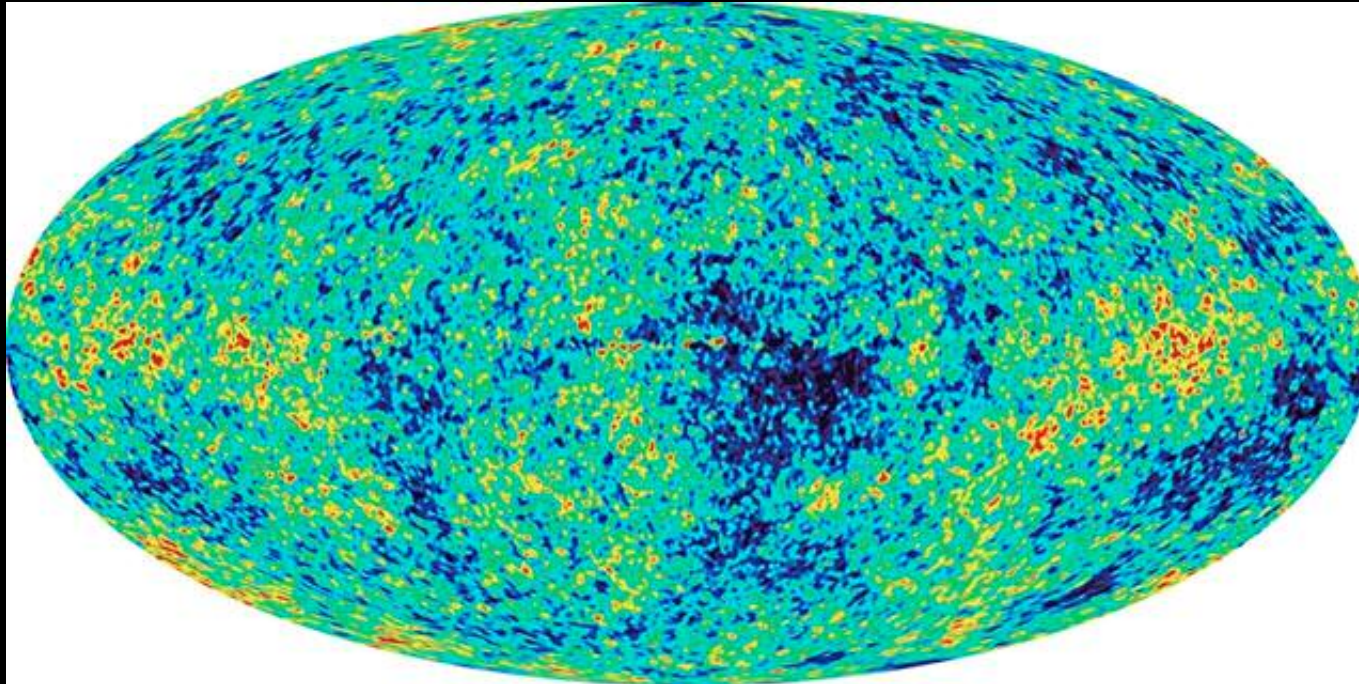



# Act V

## The background of LTD zero



**> A question was left aside  
in superconductivity :**

**Why hysteretic behavior was  
not observed  
in type I Superconductors  
in spite of  
their first order phase transition  
in magnetic field ?**

The answer : microspheres with  
“good“ surface states get it

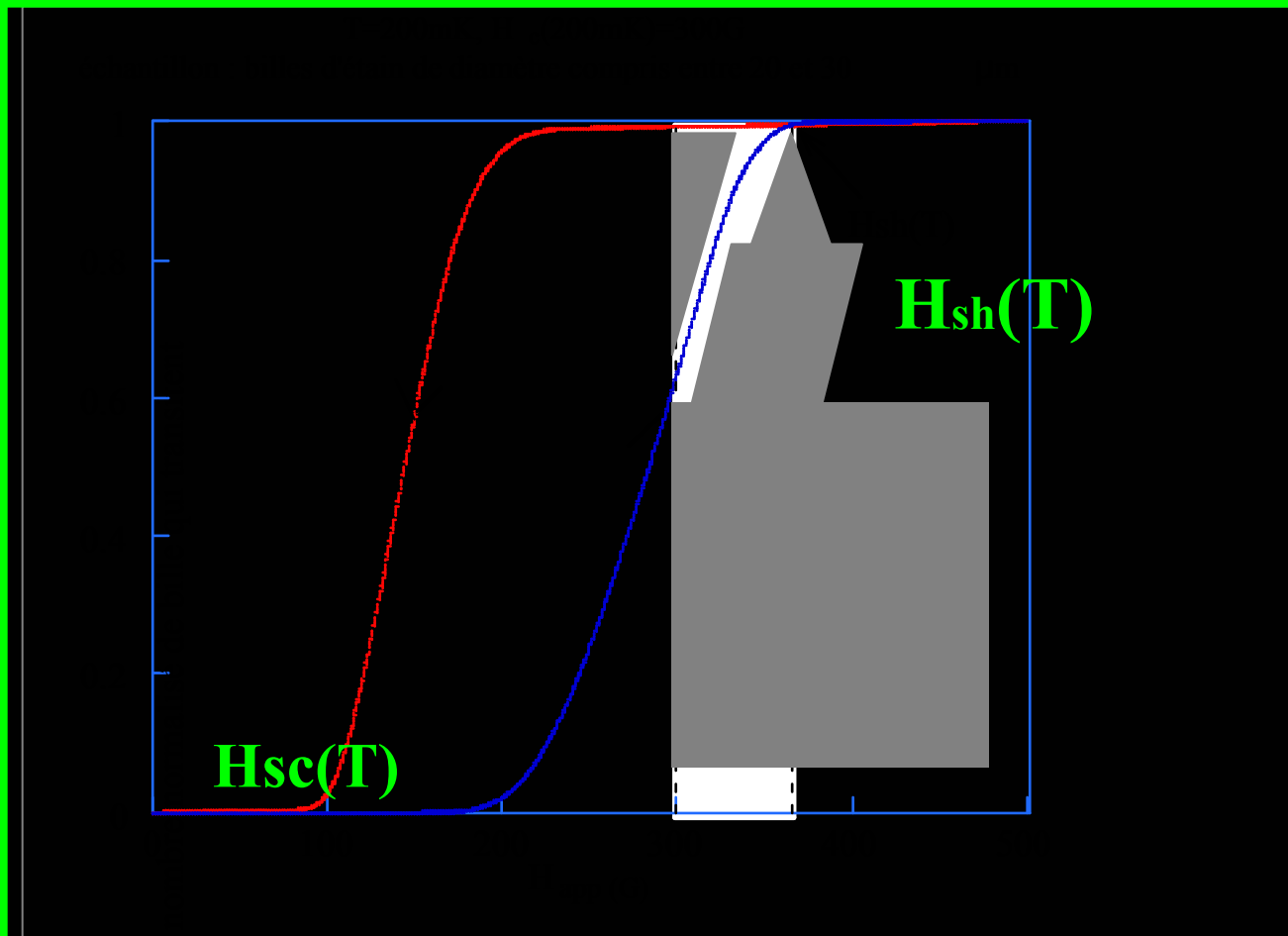

$$LC\omega^2 = 1$$



## First Transition Radiation exp . Drukier, Valette, Waysand, LCL. Yuan

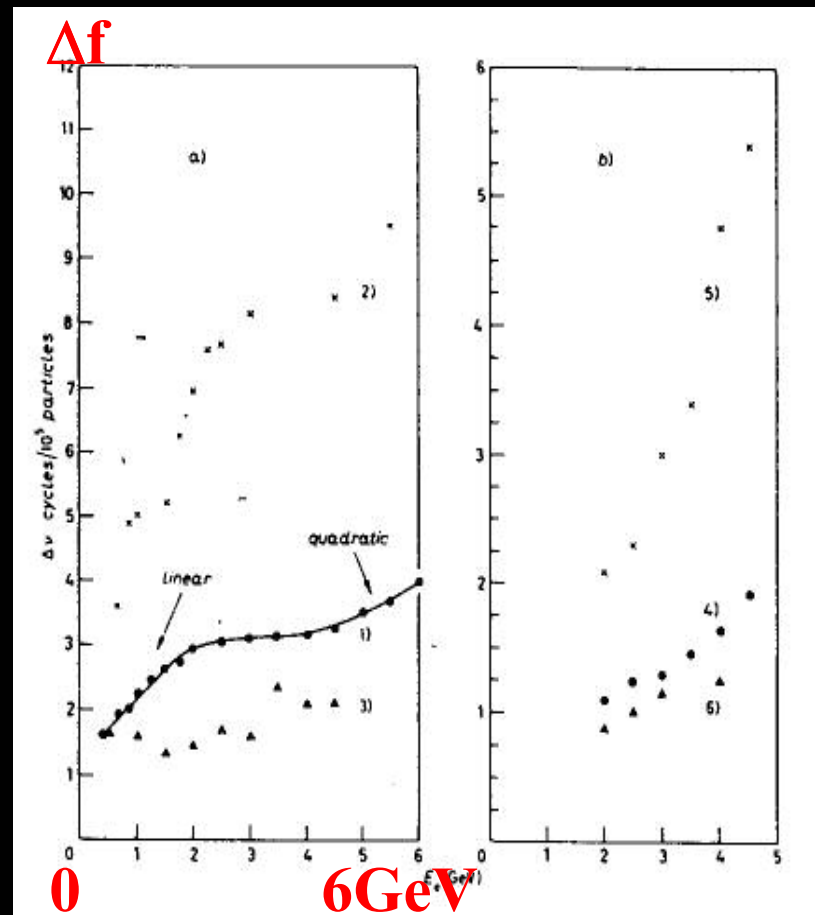

DESY 1975

our experimental  $\tau$  value for the Hg sphere to the size  $\xi(T)$ , we obtain  $\tau_0 = \frac{\pi\sigma\xi^2(T)}{p} \approx 4 \cdot 10^{-11}$  s, not so far from  $\theta \approx 10^{-12}$  s. Our conclusion is a guess that Faber's formula (1) is probably valid down to the scale of size of the initial nucleus.

References :

1. T.E. Faber, Proc. Roy. Soc. A 214, 392 (1952)
2. R.L. Chase, Ch. Gruhn, A. Hrisoho, C. Valette, G. Waysand, Proceedings of the 2nd Ispra Nuclear Electronics symposium. Ispra, EURATOM 1975
3. C. Valette, Thesis, Orsay 1971
4. H. Bernas, J.P. Burger, G. Deutscher, C. Valette, S.J. Williamson, Phys. Lett. 24A, 721 (1967)

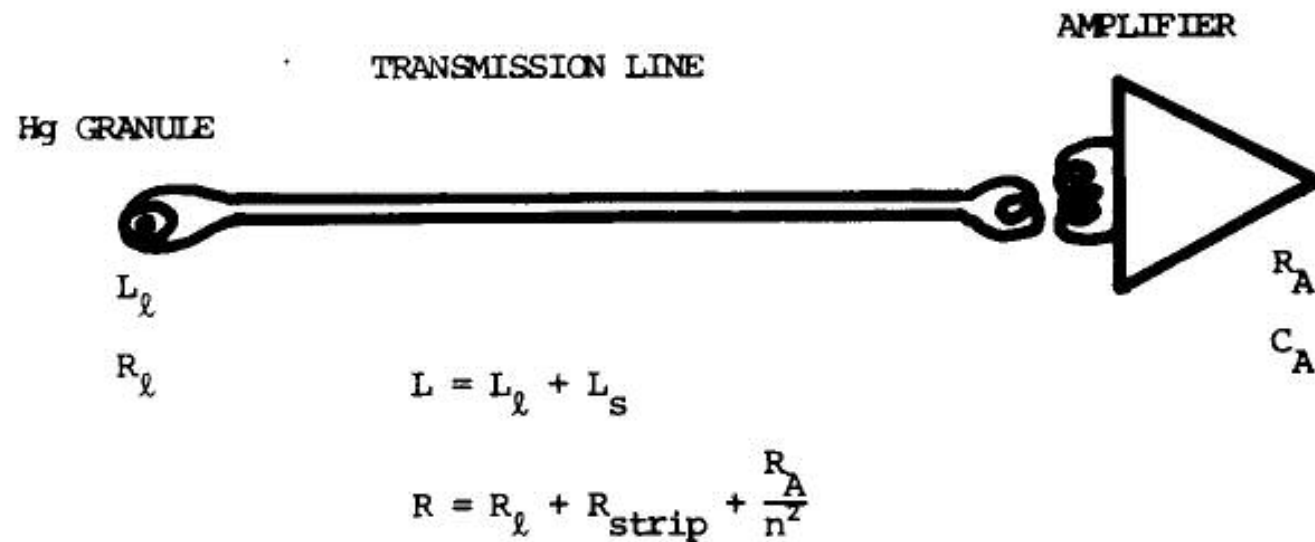
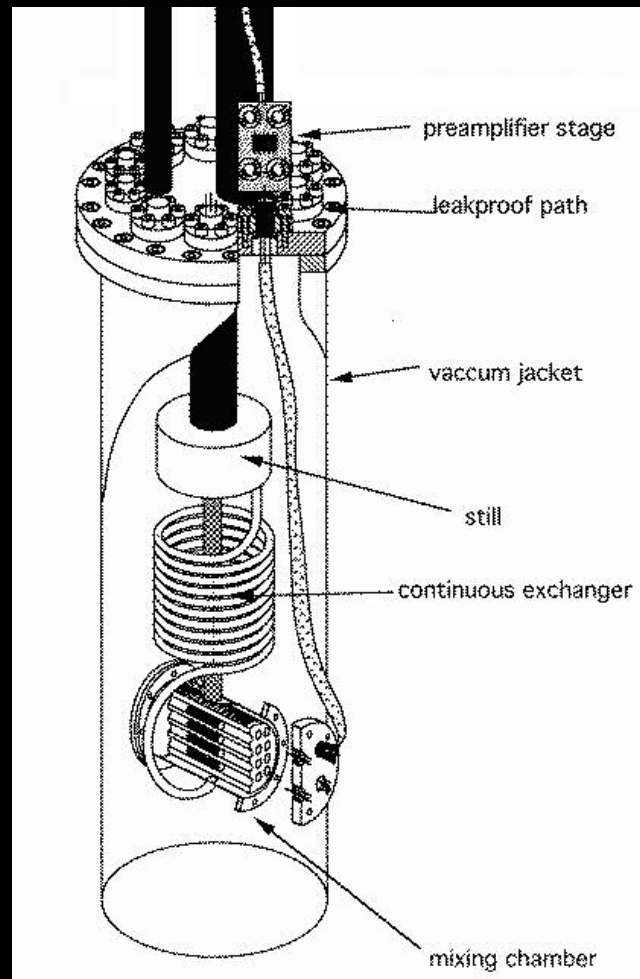
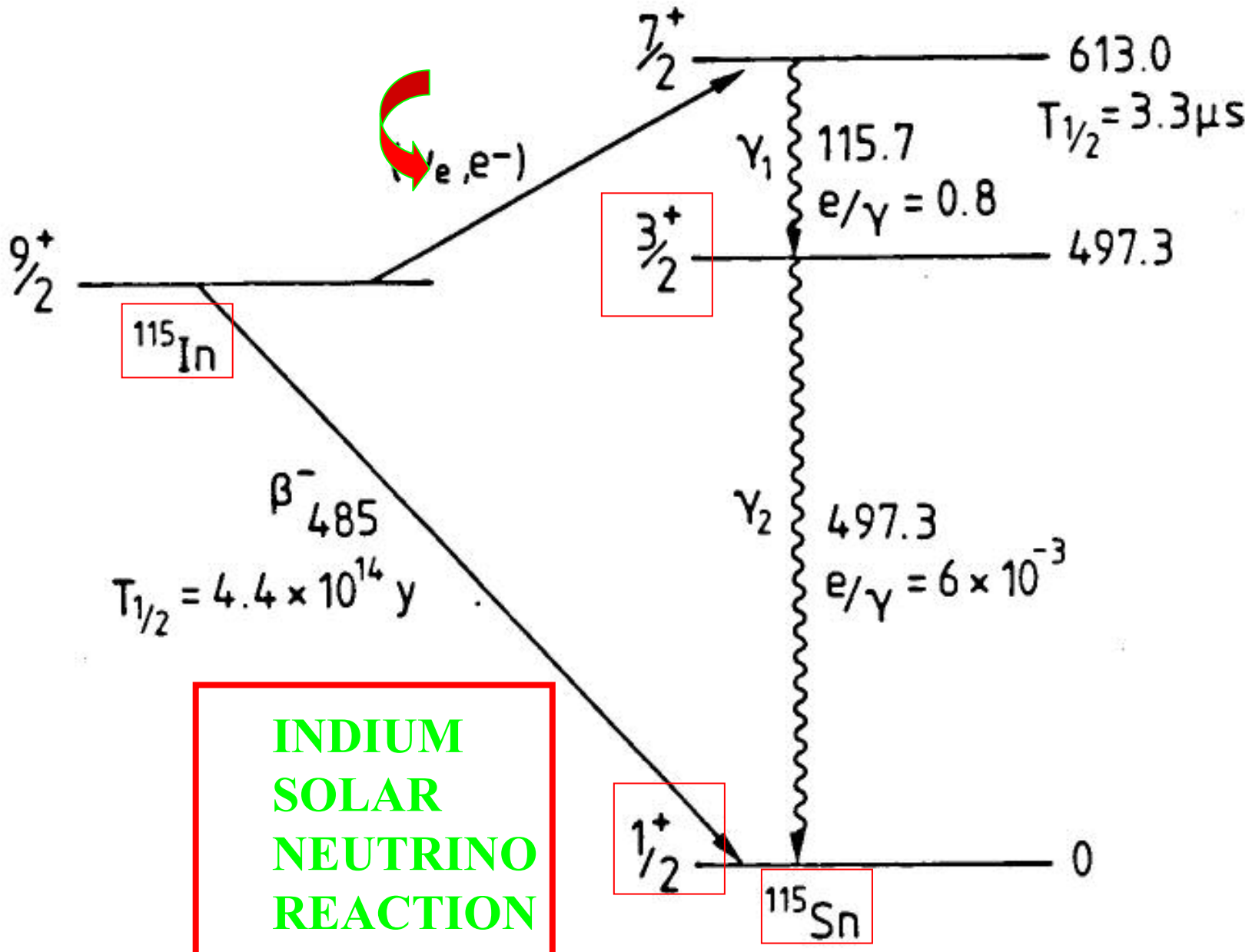

Fig.1 : Electronic diagram for flux expulsion detection

# 16 channels 50mK Transition Radiation Detector







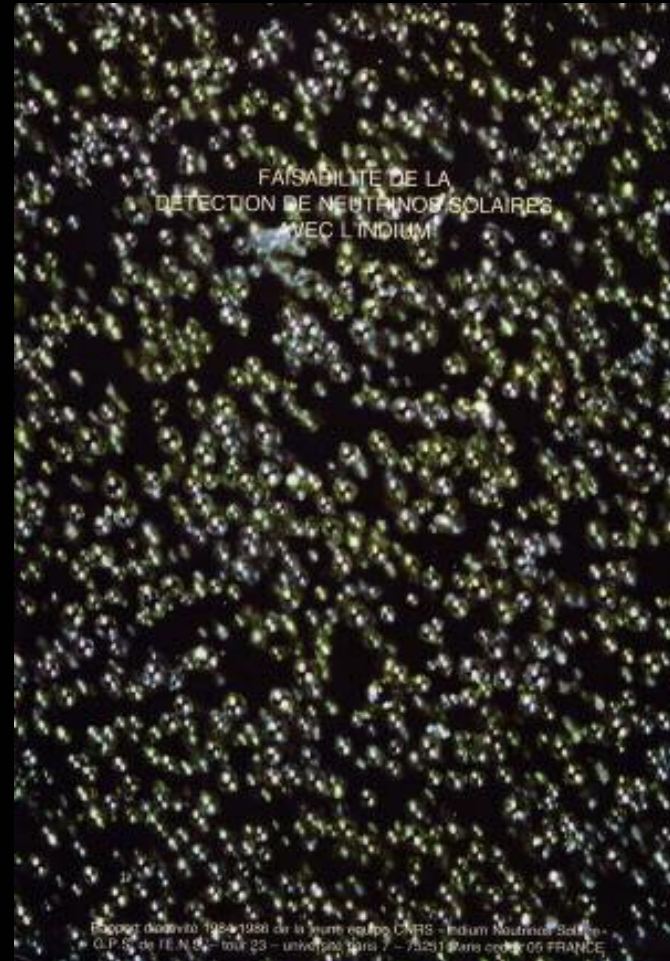

> A new opportunity to realize experiments requiring  
Magnetic fields AND low noise environment

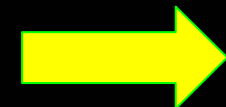



# Laboratoire Souterrain Bas Bruit

## Low Noise Underground Laboratory

### Rustrel Pays d'Apt

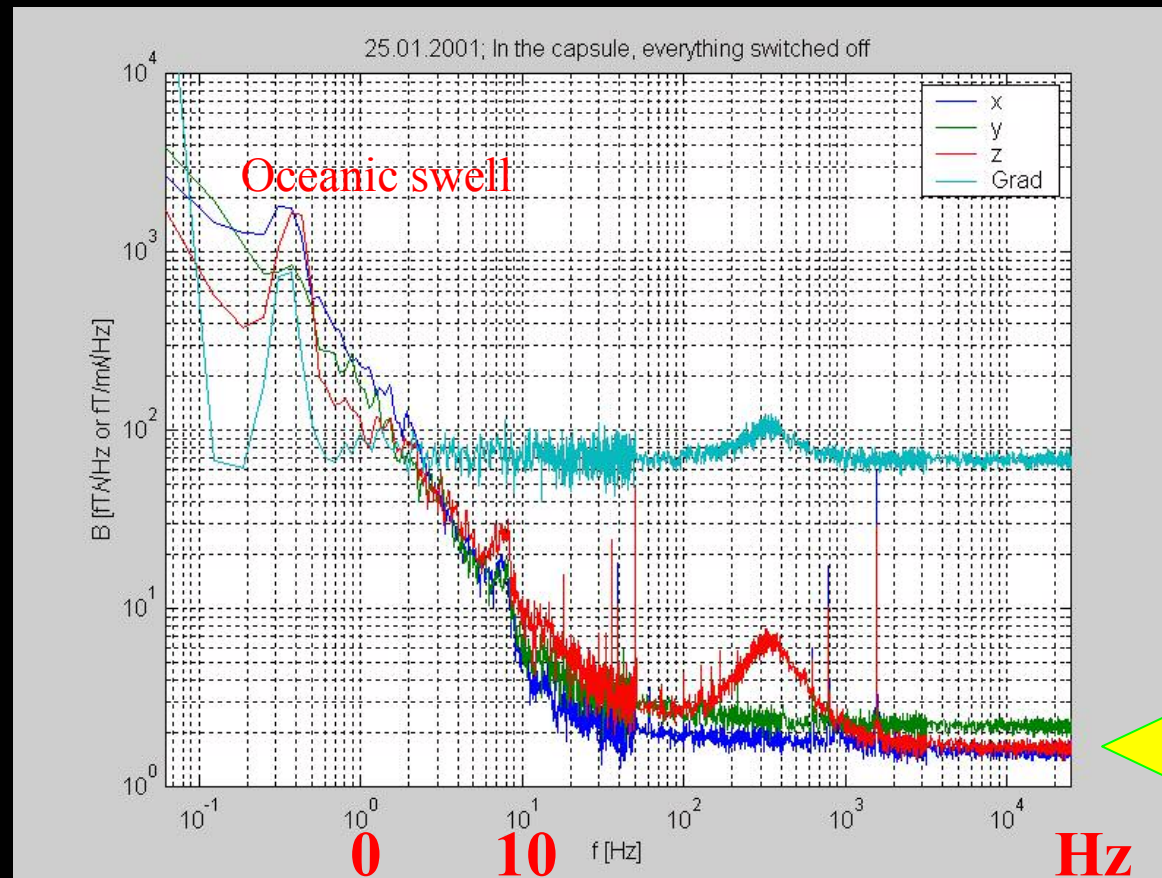

1/2  
2 femtoTesla / Hz

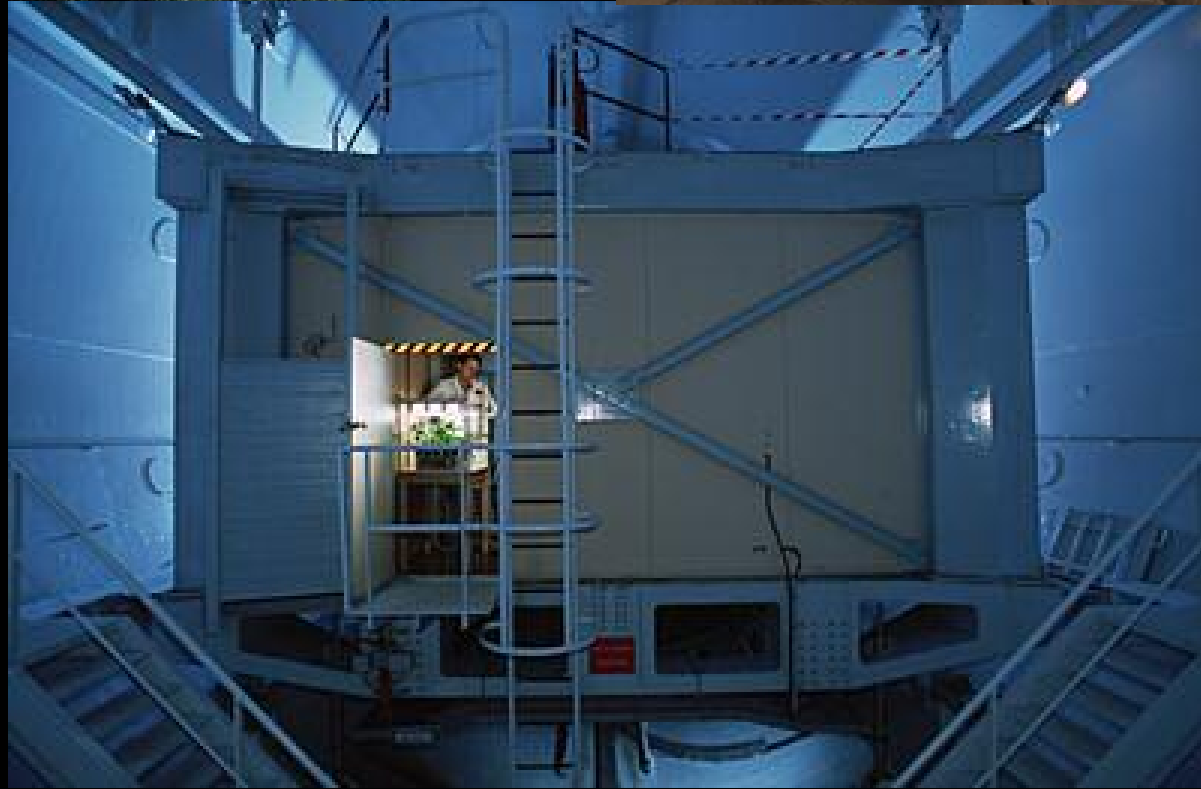

500 m below rock  
Galleries : 3km  
1250m<sup>3</sup> air-cond  
with tap water hot & cold  
ultra-shielded  
AND no  $\mu$  metal  
60km east of Avignon

more at <http://www.lsbb.univ-avignon.fr>

# LTD zero musketeers



## LIST OF PARTICIPANTS

Name	Full Address	Phone n°
Y.K. Potl	Max Planck Institut für Physik in Astrophysik München	
J.L. BADEVANT	LPTHE Tom 16 Collège de France Paris	p. 41.05
A. BARONE	ISTITUTO DI FISICA UNIVERSITA' DI GENOVA	
S. Vitale	Istituto Fisico Fisiche Università di Genova - Genova	
P. FREUND	Max Planck Inst. f. Physik in Astrophysik München	
W. Lüthy	Dorner-Straße 70A, Zürichhofen	
T. NIINIKOSKI	CERN, Geneva	
R. S. Raghovam	Bell Laboratories Murray Hill NJ 07922 USA	
P. SPILLANTINI	Laboratori Nazionali di Frascati (30) 95031 I-00044 Frascati (Roma) ITALY	
L. STODOLSKY	MAX PLANCK MUNICH	M. M. 31 993/231 1396
LEGER	GPS ENS Jussieu	
GONZALEZ-METREZ, Luis	LAPP ANNECY	
F. VANUCCI	CPNHE Paris	
B. BRUNETTE	CPNHE Paris	
WILSON	Rutherford Laboratory (CHILTON) BUCKINGHAMSHIRE	



# WORKSHOP ON METASTABLE SUPERCONDUCTORS IN PARTICLE PHYSICS PARIS 14/15 APRIL 1983

Small spheres of type I superconductors, can exhibit a metastable superheated state, thus providing new possibilities of detection in particle physics.

The aim of the present workshop is to exchange informations for a better appreciation of these possibilities.

The topics to be discussed are :

- SUPERCONDUCTING PROPERTIES
- ENERGY THRESHOLD FOR THE NUCLEATION OF THE NORMAL STATE
- TRANSITION RADIATION DETECTION
- SOLAR NEUTRINO DETECTION (WITH INDIUM)
- PERFORMANCE OF ASSOCIATED ELECTRONICS (CONVENTIONAL AND JOSEPHSON DEVICES)
- BRIEF SURVEY OF THE INDUSTRIAL APPLICATIONS UNDER REALIZATION

DEADLINE FOR REGISTRATIONS AND CONTRIBUTIONS  
March 28<sup>th</sup>, 1983

The correspondence can be addressed to :

G. WAYSAND

GPS/ENS  
Tour 23  
Université Paris VII  
75251 Paris Cedex 05

F. VANNUCCI

LPHEP  
Tour 22  
Université Paris VII  
75250 Paris Cedex 05



## SCHEDULE FOR THE WORKSHOP

(This is a proposal . Ample time is left for question and discussions)

### THURSDAY 14th

- 9h45            OPENTING
- 10h00           G. WAYSAND (GPS-ENS, Paris)  
Introduction to metastable superconducting granules  
(30 minutes plus discussion)
- 10h45           Break
- 11 h            A. HRISOHO (I.LAL, Orsay)  
Associated electronics for metastable superconducting detectors  
(15 minutes plus discussion)
- 11h25           D. PERRET-GALLIX (L.A.P.P, Annecy) L.C.L. YUAN (Brookhaven), G. WAYSAND  
(GPS-ENS)  
Transition radiation and metastable superconducting detectors.
- 12h            Lunch
- 14h30           C. VANNESTE (Nice) and N.PERRIN (GPS-ENS)  
1 - General presentation of Josephson effects  
2 - Relaxation times in non-equilibrium supraconductors.
- 15h            F. CELANI (Frascati), R. FALCIONI (Frascati), S. PACE (Univ.of Salerno),  
P. SPILLANTINI (I.N.F.N.)  
Preliminary results on noise from a fast charge amplifier coupled to  
superconducting tunnel junctions.
- 15h20           Round Table on Josephson devices for metastable superconducting detectors  
(state of art in junctions, squids, etc...)

### FRIDAY 15th

- 10h            R.S. RAGHAVAN (Bell Labs.)  
Actual status of the project of solar neutrino detection with indium.
- 10h30           L. STODOLSKY (Max Planck Institute, Munich)  
Neutral current detector for neutrino physics and astronomy.
- 11h20           Discussion on these projects in relation with superheated superconducting  
detectors. Present detectors in construction.
- 12h            Lunch
- 14h30           Visit of the experimental set-up for metastable superconductivity.
- 15h            Discussion on programs and eventual collaborations.



**The end**



