

# Large area NIS refrigerators with 130 mK temperature reduction for cryogenic detectors



**A. M. Clark**

**J. N. Ullom**

*National Institute of Standards and Technology, Boulder, CO*

**M. L. van den Berg**

*European Space Agency – ESTEC, The Netherlands*

**A. Williams**

**S. T. Ruggiero**

*University of Notre Dame, Notre Dame, IN*

*NASA Cross-Enterprise Technology Development Program*

*NIST Office of Microelectronic Programs*

**NIST**

**National Institute of Standards and Technology**  
Technology Administration, U.S. Department of Commerce

# Overview



Goal: To cool a cryogenic sensor from 300 mK to 100 mK  
with an on-chip, solid-state refrigerator

Requirements: Large temperature reduction  
High cooling powers ( $> 10$  pW)

Challenges: Good performance in large area junctions  
Integration

# NIS Operation

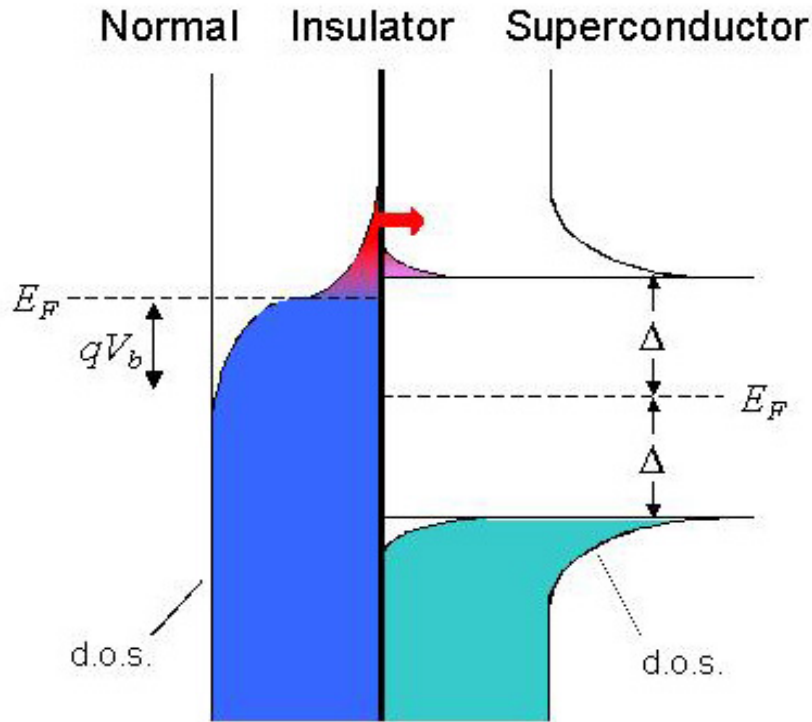

Current-Voltage Curve of NIS Junction

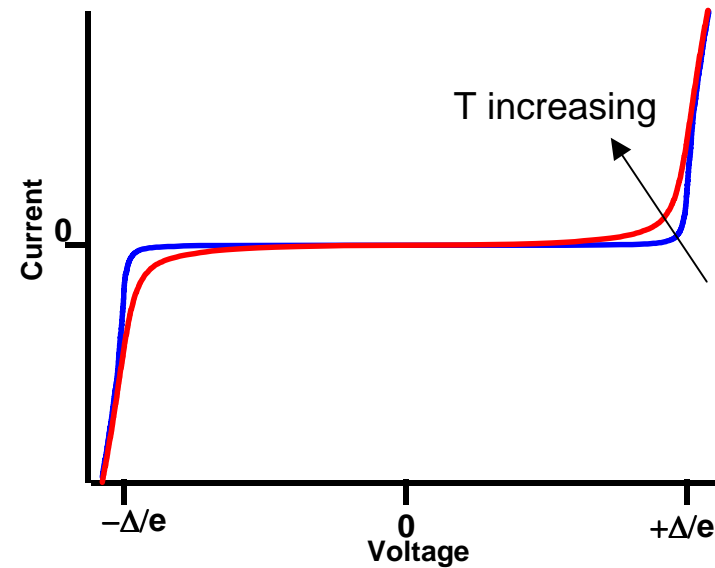

- Bias  $V_b$  shifts Fermi level
- Hottest electrons tunnel from normal metal
- Cooling maximum near  $0.9\Delta/e$

# NIS Device Design



Standard Topography

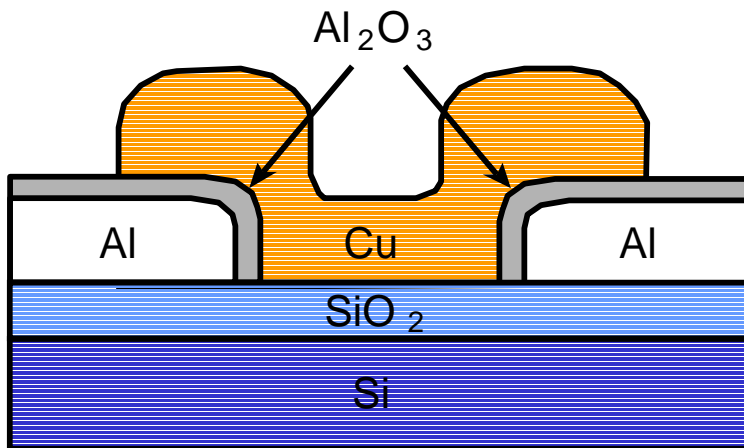

New Topography

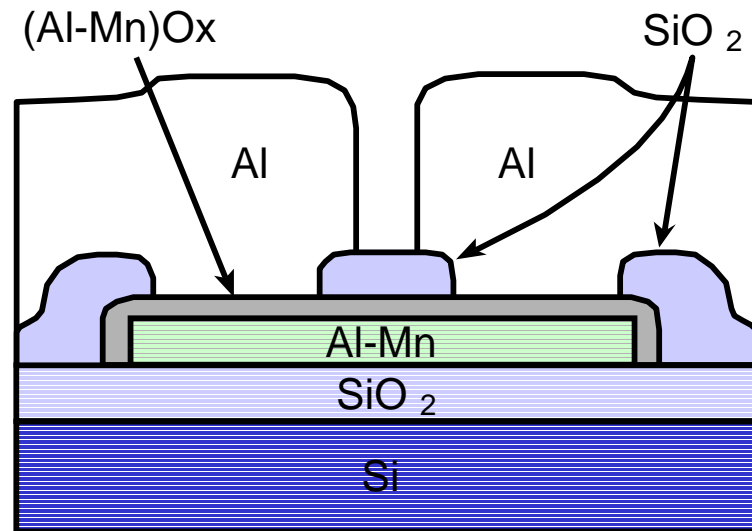

- New normal metal with high quality oxide (Al:Mn)
- Topography reversed
- Fabrication entirely lithographic

# Device Photo



Two pair NIS Junctions, biased in series

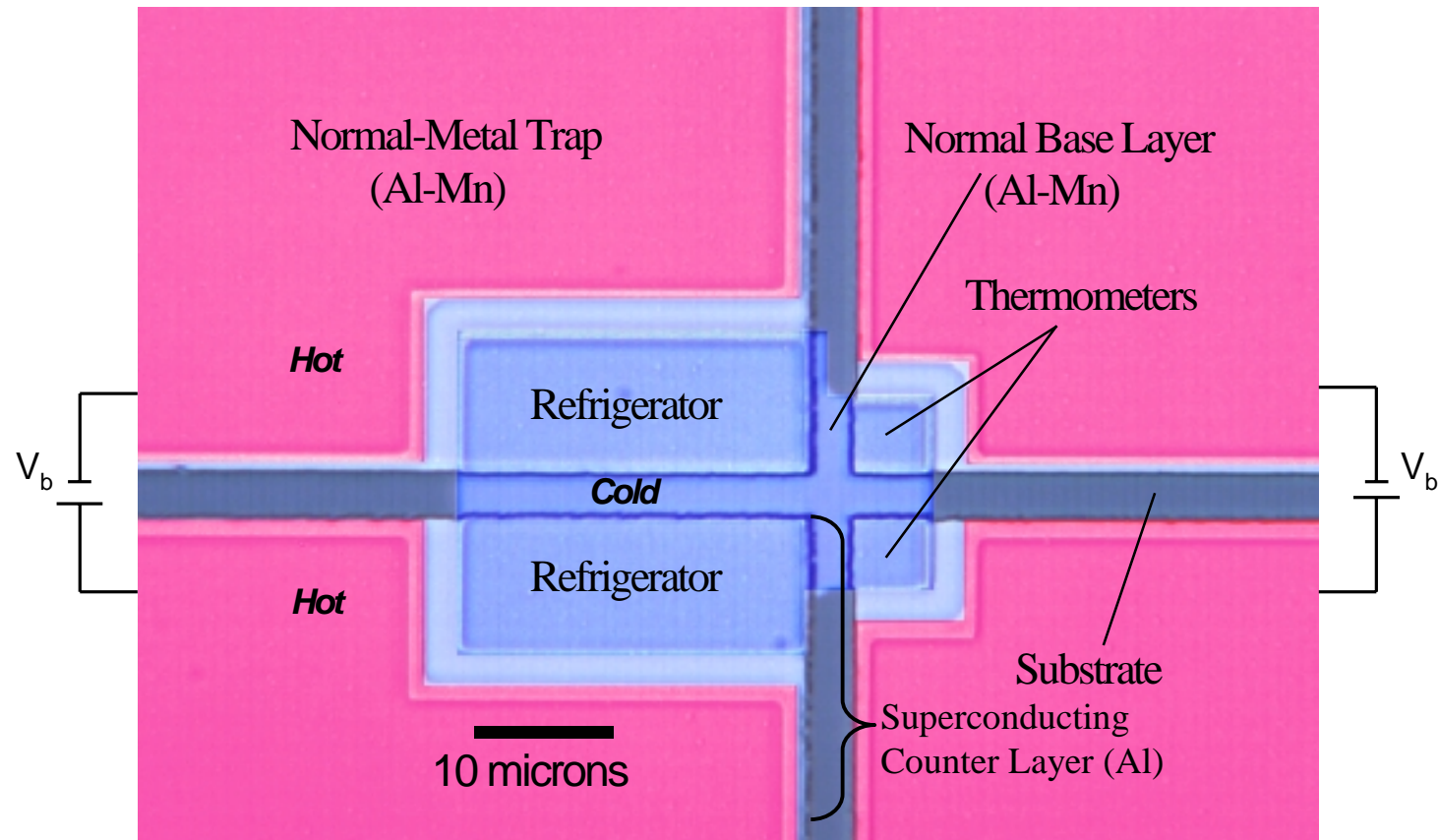

# Demonstration of Cooling from $T_{\text{bath}} = 260\text{mK}$

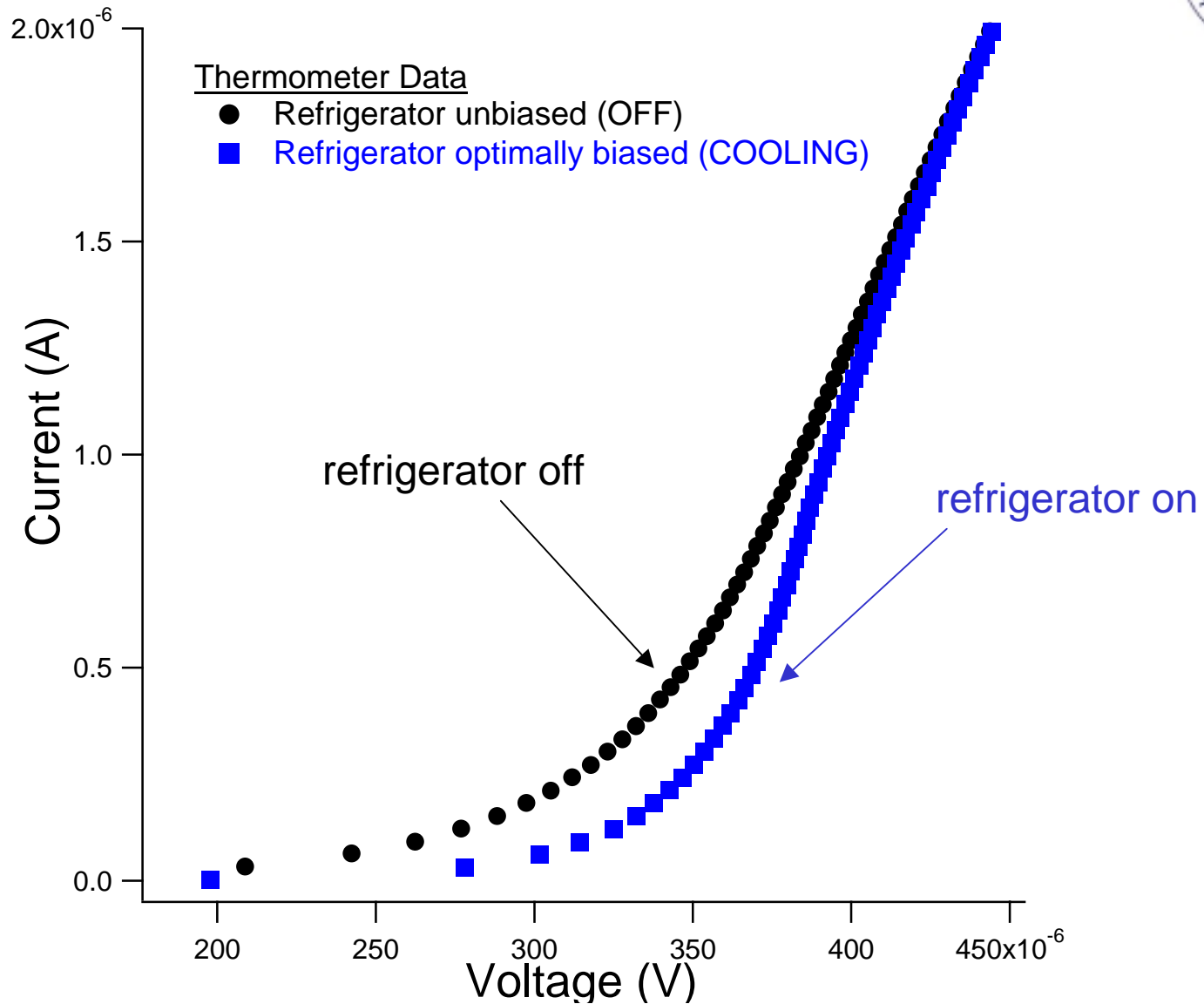

# Isothermal Theory and Cooling from $T_{\text{bath}} = 260 \text{ mK}$

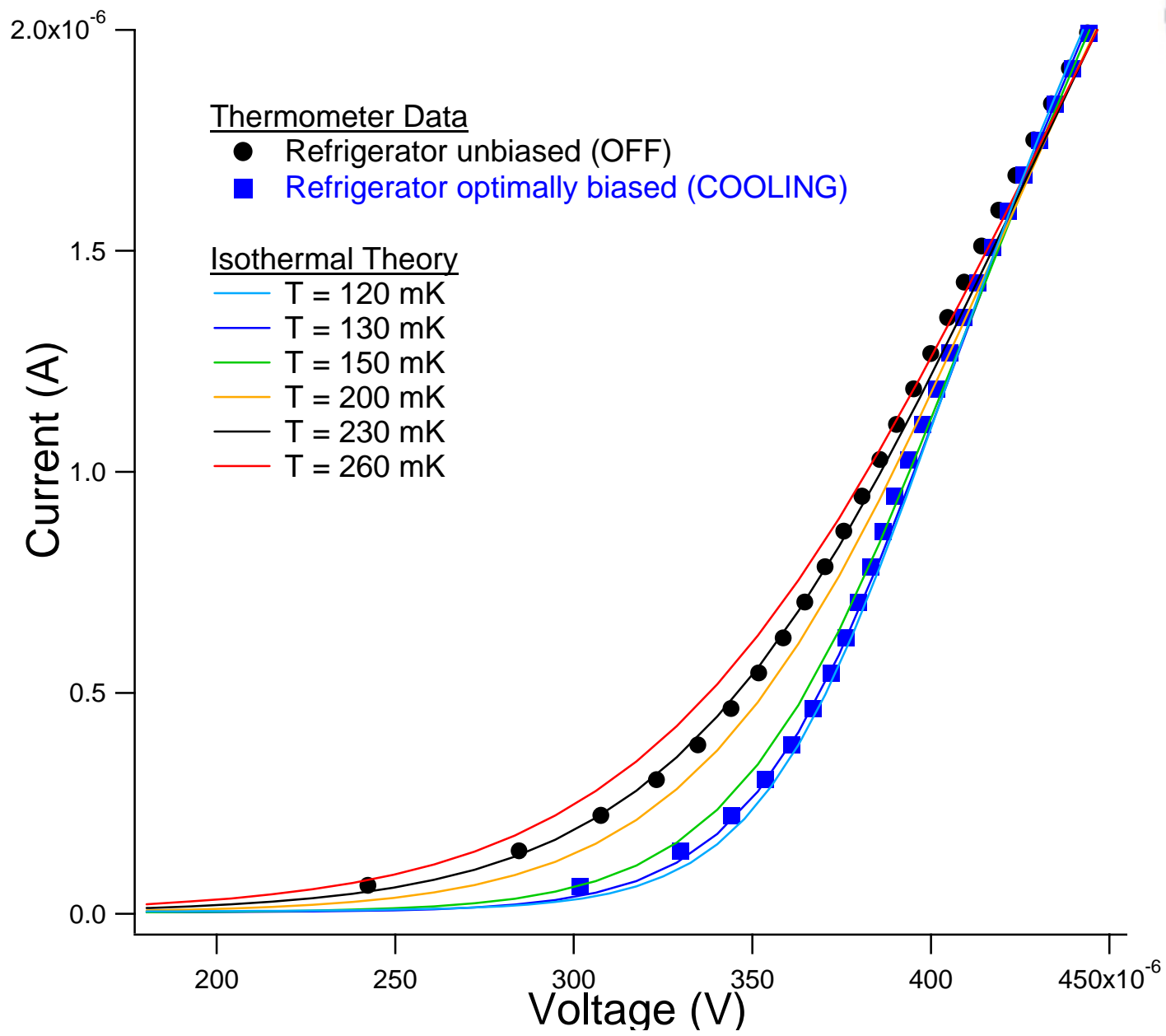

# Detailed Thermal Model



- Recalculate device temperature at each bias point
- Equilibrium temperature  $T_N$ :

$$P_{\text{cool}}(T_N) = P_{\text{load}}(T_N)$$

- Power loads:

Electron-phonon

$$P_{ep} = \Sigma \Omega (T_{bath}^5 - T_N^5)$$

Leakage resistance

$$P_{lk} = V_b^2 / R_{lk}$$

Quasiparticle power return

$$P_{qp} = \beta (P_{cool} + IV_b)$$



# Success of Thermal Model

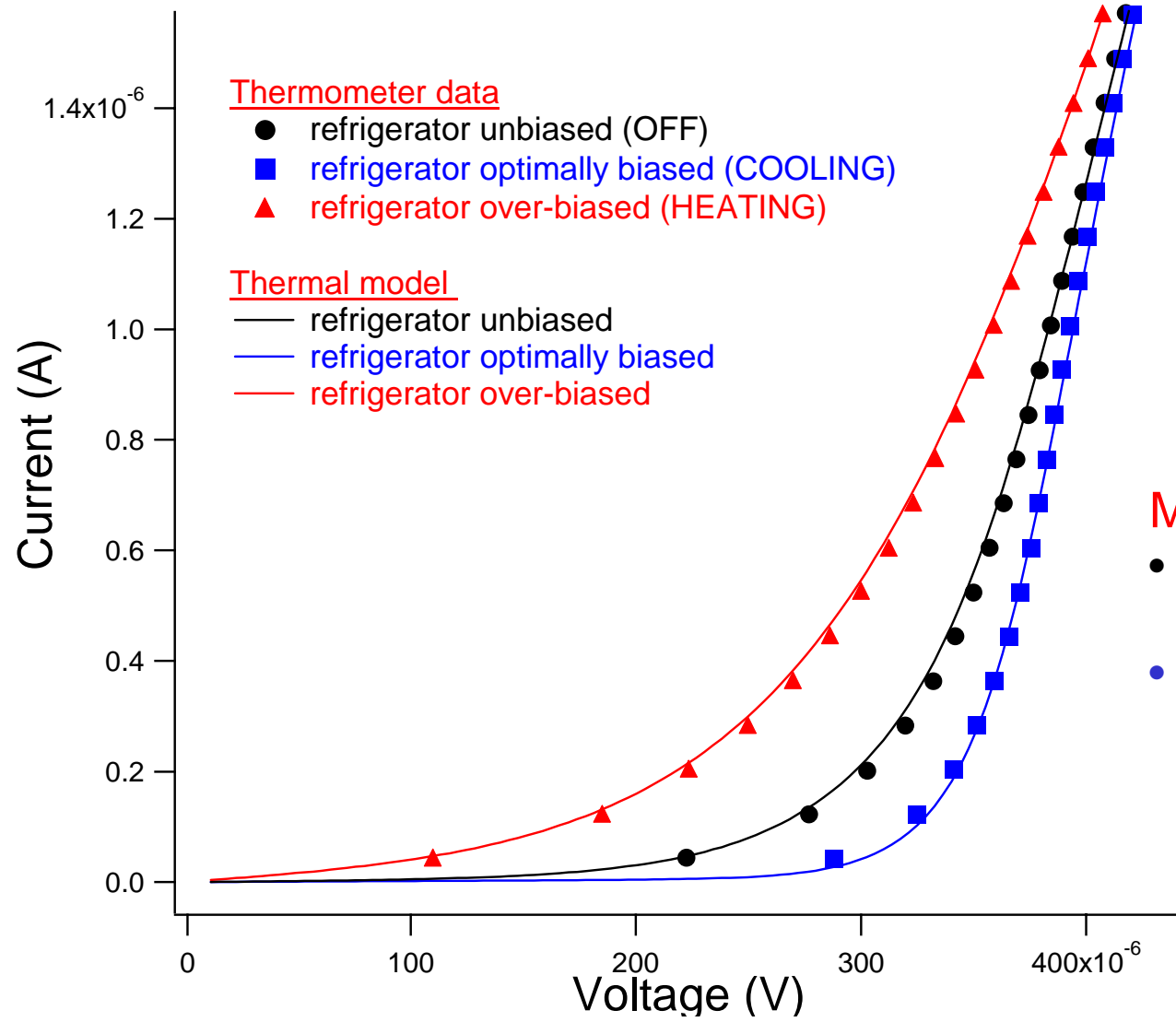

## Thermometer data

- refrigerator unbiased (OFF)
- refrigerator optimally biased (COOLING)
- ▲ refrigerator over-biased (HEATING)

## Thermal model

- refrigerator unbiased
- refrigerator optimally biased
- refrigerator over-biased

## Fitting Parameters:

$$\Sigma = 1.1 \text{ nW/K}^5\mu\text{m}^3$$

$$\beta_{\text{fridge}} = 0.04$$

$$\beta_{\text{therm}} = 0.035$$

## Model Results:

- Thermometer self cools to  $T_{\text{min}} = 237 \text{ mK}$
- $T_{\text{min}} = 131 \text{ mK}$  under refrigerator bias

# Present and Future NIS Device Performance



Present Device		
Junction Size	Power Load	$T_{\min}$
10 $\diamond$ 25 $\mu\text{m}^2$	0 pW	131 mK
10 $\diamond$ 25 $\mu\text{m}^2$	10 pW	139 mK
Larger Device		
10 $\diamond$ 250 $\mu\text{m}^2$	100 pW	139 mK
Improved Device ( $\beta = 0$ )		
10 $\diamond$ 250 $\mu\text{m}^2$	100 pW	67 mK

# Next Generation NIS Refrigerator

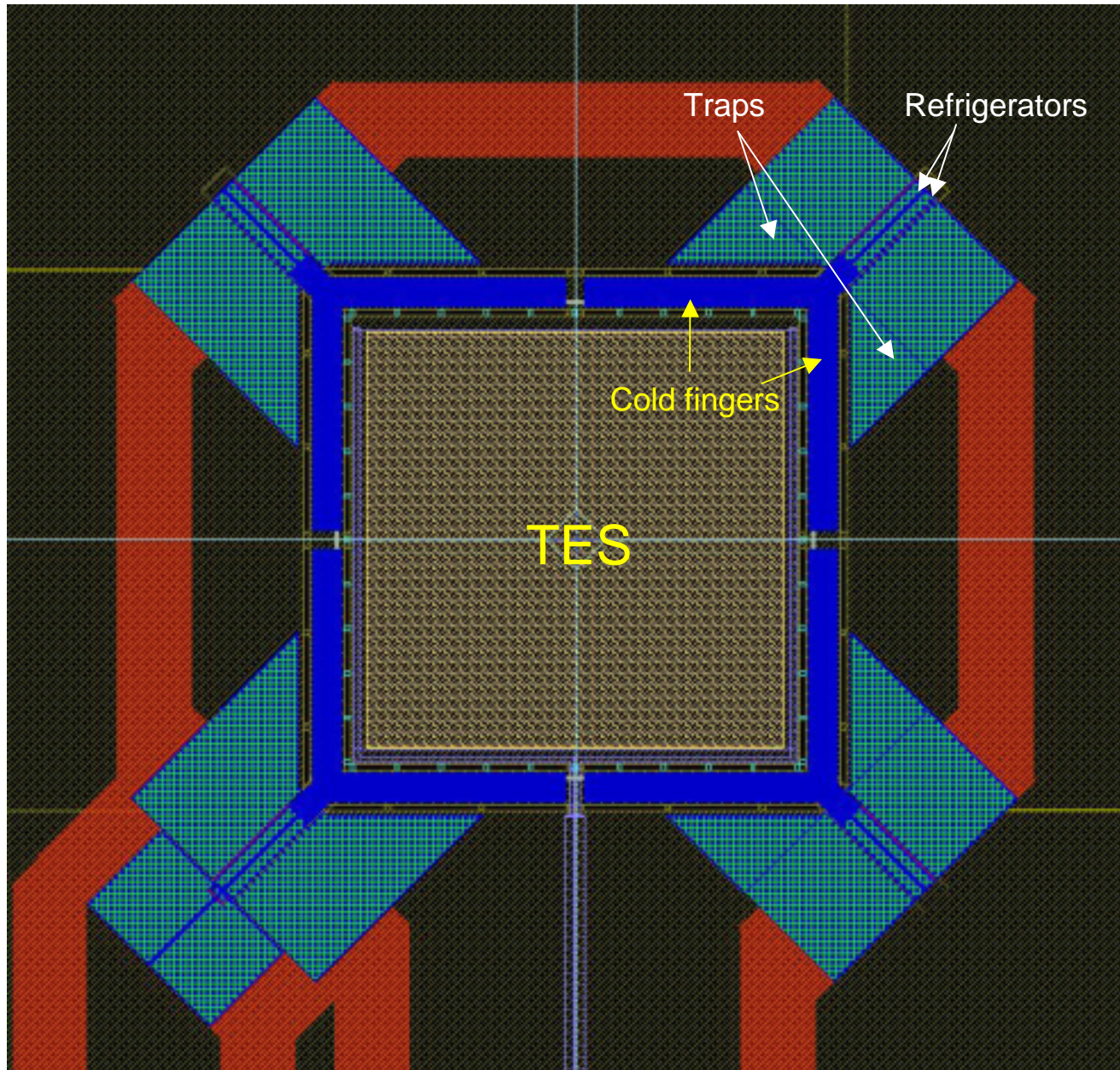

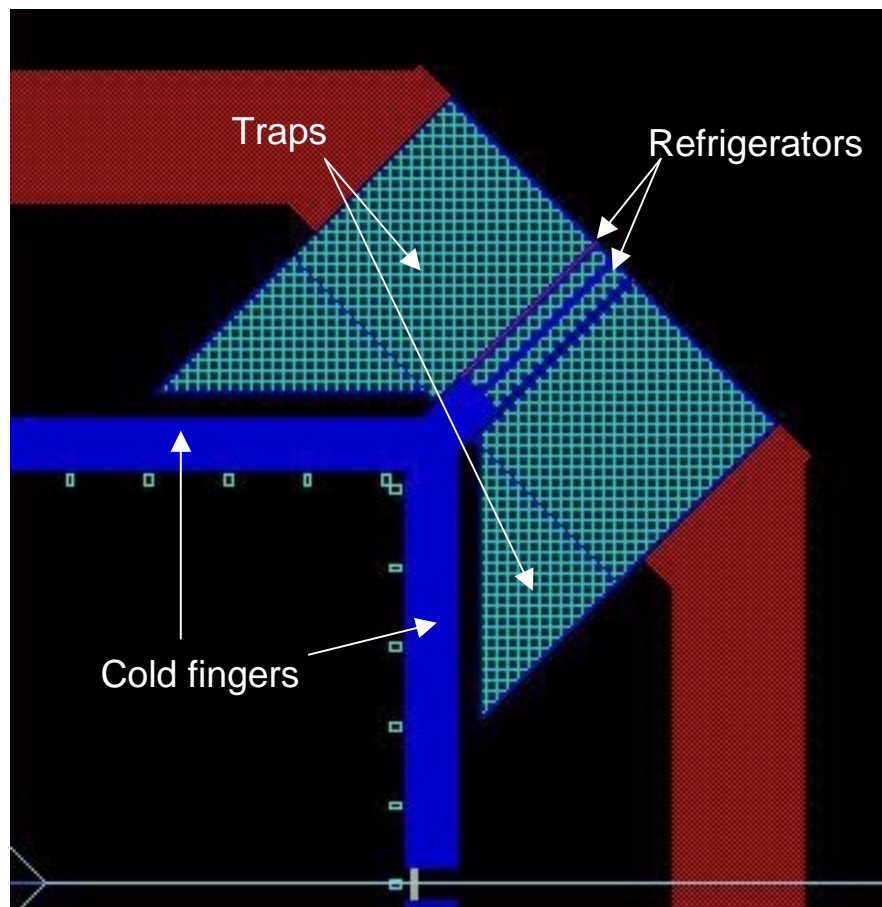

# Summary



- We have achieved cooling from  $T_{\text{bath}} = 260 \text{ mK}$  to  $T = 131 \text{ mK}$
- Cooling power matched to bias power of cryogenic sensor
- Novel device topography
- Fabrication entirely lithographic – scalable to larger areas and complex geometries
- Easily coupled to other cryogenic devices